

40W isolated DC/DC converter,
Wide input and regulated single output



FEATURES

- Wide 2:1 input voltage range
- High efficiency up to 91%
- No-load power consumption as low as 0.3W
- I/O isolation test voltage: 1.5K VDC
- Output short-circuit, over-voltage, over-current protection
- Operating ambient temperature range: -40°C to +85°C
- Six-sided metal shielded package
- Input reverse polarity protection available with chassis (A2S) or DIN-Rail mounting (A4S) version
- Industry standard pin-out

VRB_LD-40W(H)R3(A2S/A4S) series are isolated 40W DC-DC products with 2:1 input voltage. They feature efficiency up to 91%, 1500VDC isolation, operating temperature of -40°C to +85°C, output short circuit protection, over-voltage protection, over-current protection, which make them widely applied in data transmission device, battery power supply device, telecommunication device, distributed power supply system, remote control system, industrial robot fields.

Selection Guide

Certification	Part No. ^①	Input Voltage (VDC)		Output		Full Load Efficiency ^④ (%) Min./Typ.	Max. Capacitive Load(μF)
		Nominal (Range)	Max. ^②	Voltage (VDC)	Current (mA) Max./Min.		
--	VRB2405LD-40WR3(A2S/A4S)	24 (18-36)	40	05	8000/0	86/88	10000
	VRB2412LD-40WR3(A2S/A4S)			12	3333/0	88/90	2700
	VRB2415LD-40WR3(A2S/A4S)			15	2667/0	90/91	1680
	VRB2424LD-40WR3(A2S/A4S)			24	1667/0	90/91	680
	VRB4812LD-40WR3(A2S/A4S)	48 (36-75)	80	12	3333/0	88/90	2700
	VRB4815LD-40WR3(A2S/A4S)			15	2667/0	90/91	1680
	VRB4824LD-40WR3(A2S/A4S)			24	1667/0	90/91	680
EN/BS EN	VRB2405LD-40WHR3(A2S/A4S)	24 (18-36)	40	05	8000/0	86/88	10000
	VRB2412LD-40WHR3(A2S/A4S)			12	3333/0	88/90	2700
	VRB2415LD-40WHR3(A2S/A4S)			15	2667/0	90/91	1680
	VRB2424LD-40WHR3(A2S/A4S)			24	1667/0	90/91	680
	VRB4812LD-40WHR3(A2S/A4S)	48 (36-75)	80	12	3333/0	88/90	2700
	VRB4815LD-40WHR3(A2S/A4S)			15	2667/0	90/91	1680
	VRB4824LD-40WHR3(A2S/A4S)			24	1667/0	90/91	680

Notes:
 ①Use "H" suffix for heat sink mounting, with "H" products EN62368 approved, without "H" products meets EN62368 test standards;
 ②The minimum input voltage and starting voltage of A2S and A4S model are 1VDC higher than those of DIP package due to input reverse polarity protection function;
 ③Exceeding the maximum input voltage may cause permanent damage;
 ④Efficiency is measured in nominal input voltage and rated output load; efficiencies for A2S and A4S model is decreased by 2% due to the input reverse polarity protection circuit.

Input Specifications

Item	Operating Conditions		Min.	Typ.	Max.	Unit
Input Current (full load / no-load)	24VDC input	VRB2405LD-40W(H)R3(A2S/A4S)	--	1894/60	1938/100	mA

		Other outputs	--	1852/12	1894/25	
	48VDC input		--	926/12	947/25	
Reflected Ripple Current	Nominal input voltage		--	30	--	mA
Surge Voltage (1sec. max.)	24VDC input		-0.7	--	50	VDC
	48VDC input		-0.7	--	100	
Input Under-voltage Protection	24VDC input		13	15.5	--	
	48VDC input		26	33	--	
Start-up Voltage	24VDC input		--	--	18	
	48VDC input		--	--	36	
Start-up Time	Nominal input voltage & constant resistance load		--	10	150	ms
Input Filter	PI filter					
Hot Plug	Unavailable					
Ctrl *	Module on	Ctrl pin open or pulled high (3.5-12VDC)				
	Module off	Ctrl pin pulled low to GND (0-1.2VDC)				
	Input current when off	--	5	10	mA	

Note: *The Ctrl pin voltage is referenced to input GND.

Output Specifications

Item	Operating Conditions		Min.	Typ.	Max.	Unit
Voltage Accuracy	VRB2405LD-40WHR3(A2S/A4S) ^①	5%-100% load	--	±1	±3	%
	Other outputs	0%-100% load				
Linear Regulation	Input voltage variation from low to high at full load		--	±0.2	±0.5	%
Load Regulation	VRB2405LD-40WHR3(A2S/A4S) ^②	5%-100% load	--	±0.5	±1	%
	Other outputs	0%-100% load				
Transient Recovery Time			--	300	500	µs
Transient Response Deviation	25% load step change, nominal input voltage	VRB2405LD-40W(H)R3(A2S/A4S)	--	±5	±8	%
		Other outputs	--	±3	±5	
Temperature Coefficient	Full load		--	--	±0.03	%/°C
Ripple & Noise ^③	20MHz bandwidth, nominal input voltage, 100% load		--	50	100	mV p-p
Trim			--	±10	--	%Vo
Over-voltage Protection			110	--	160	
Over-current Protection	Input voltage range		110	--	190	%Io
Short-circuit Protection	Hiccup, continuous, self-recovery					

Note:

①VRB2405LD-40W(H)R3(A2S/A4S) 0%-100% output voltage accuracy 5% max;

②VRB2405LD-40W(H)R3(A2S/A4S) 0%-100% Load Regulation 5% max;

③The "parallel cable" method is used for Ripple and Noise test, please refer to *DC-DC Converter Application Notes* for specific information.

General Specifications

Item	Operating Conditions	Min.	Typ.	Max.	Unit
Isolation	Input-output Electric Strength Test for 1 minute with a leakage current of 1mA max.	1500	--	--	VDC
Insulation Resistance	Input-output resistance at 500VDC	1000	--	--	MΩ
Isolation Capacitance	Input-output capacitance at 100KHz/0.1V	--	2000	--	pF
Operating Temperature	See Fig. 1	-40	--	+85	°C
Storage Temperature		-55	--	+125	
Storage Humidity	Non-condensing	5	--	95	%RH
Pin Soldering Resistance Temperature	Soldering spot is 1.5mm away from case for 10 seconds	--	--	300	°C
Vibration	10-55Hz, 10G, 30 Min. along X, Y and Z				

Switching Frequency *	PWM mode	--	300	--	KHz
MTBF	MIL-HDBK-217F@25°C	500	--	--	K hours

Note:*Switching frequency is measured at full load. The module reduces the switching frequency for light load (below 50%) efficiency improvement.

Mechanical Specifications

Case Material	Aluminum alloy				
Dimensions	Without heat sink	Horizontal package	50.80 x 25.40 x 11.80 mm		
		A2S wiring package	76.00 x 31.50 x 21.20 mm		
		A4S rail package	76.00 x 31.50 x 25.80 mm		
	With heat sink	Horizontal package	51.40 x 26.20 x 16.50 mm		
		A2S wiring package	76.00 x 31.50 x 25.30 mm		
		A4S rail package	76.00 x 31.50 x 29.90 mm		
Weight	Without heat sink	Horizontal package/A2S wiring package/A4S rail package		26.8g/49.8g/69.8g(Typ.)	
	With heat sink	Horizontal package/A2S wiring package/A4S rail package		36.0g/59.0g/79.0g(Typ.)	
Cooling Method	Free air convection				

Electromagnetic Compatibility (EMC)

Emissions	CE	CISPR32/EN55032	CLASS B (see Fig.3-② for recommended circuit)			
	RE	CISPR32/EN55032	CLASS B (see Fig.3-② for recommended circuit)			
Immunity	ESD	Other outputs	IEC/EN61000-4-2	Contact ±6KV	perf. Criteria A	
		VRB2405LD-40W(H)R3 (A2S/A4S)	IEC/EN61000-4-2	Contact ±4KV	perf. Criteria B	
	RS		IEC/EN61000-4-3	10V/m	perf. Criteria A	
	EFT	Other outputs	IEC/EN61000-4-4	±2KV (see Fig.3-① for recommended circuit)		perf. Criteria A
		VRB2405LD-40W(H)R3 (A2S/A4S)	IEC/EN61000-4-4	±2KV (see Fig.3-① for recommended circuit)		perf. Criteria B
	Surge	Other outputs	IEC/EN61000-4-5	line to line ±2KV (see Fig.3-① for recommended circuit)		perf. Criteria A
		VRB2405LD-40W(H)R3 (A2S/A4S)	IEC/EN61000-4-5	line to line ±2KV (see Fig.3-① for recommended circuit)		perf. Criteria B
	CS	Other outputs	IEC/EN61000-4-6	10 Vr.m.s		perf. Criteria A
VRB2405LD-40W(H)R3 (A2S/A4S)		IEC/EN61000-4-6	3 Vr.m.s		perf. Criteria A	

Typical Characteristic Curves

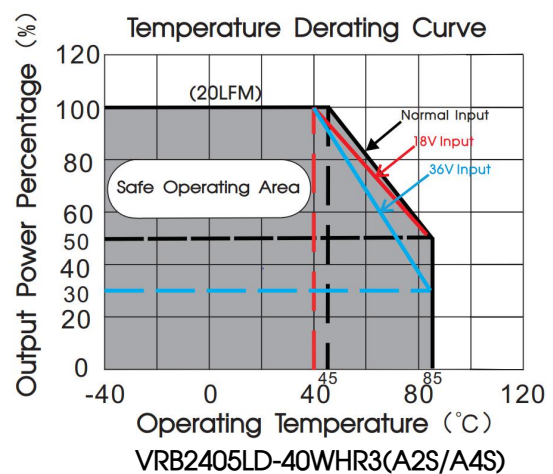
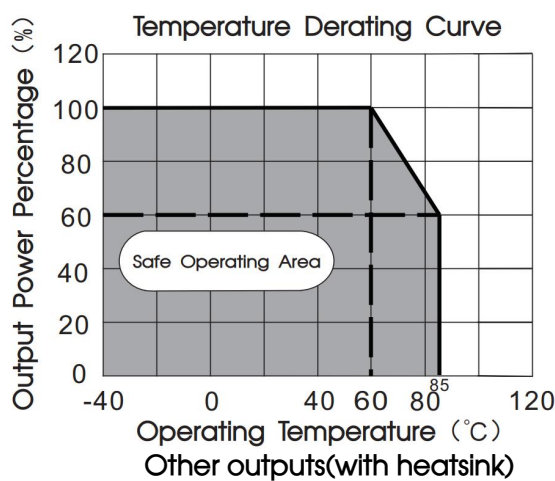
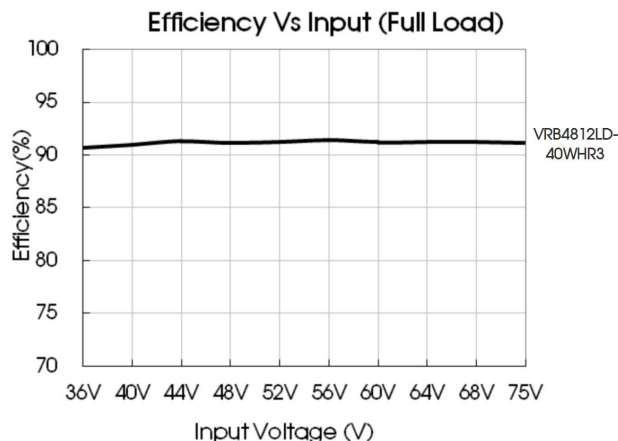
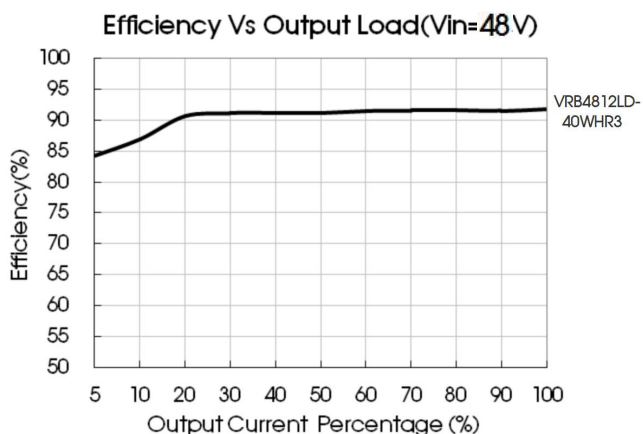
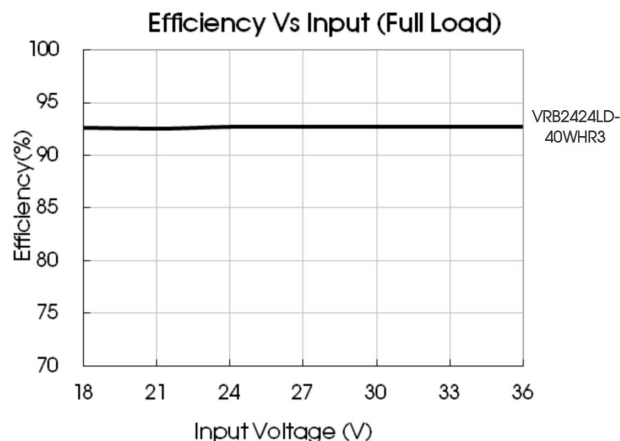
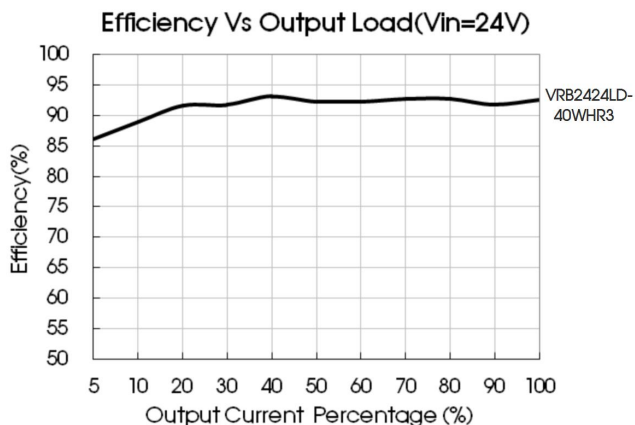

Fig. 1



Design Reference

1. Typical application

All DC-DC converters of this series are tested before delivery using the recommended circuit shown in Fig. 2.

Input and/or output ripple can be further reduced by appropriately increasing the input & output capacitor values C_{in} and C_{out} and/or by selecting capacitors with a low ESR (equivalent series resistance). Also make sure that the capacitance is not exceeding the max. capacitive load value of the product.



Fig.2

output voltage (VDC)	C_{out} (μF)	C_{in} (μF)
5/12/15/24	100	100

2. EMC solution-recommended circuit

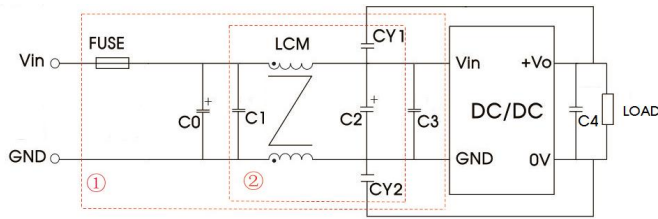

Fig. 3

Notes: For EMC tests we use Part ① in Fig. 3 for immunity and part ② for emissions test. Selecting based on needs.

Parameter description

Model	Vin:24V	Vin:48V
FUSE	Choose according to actual input current	
C0	680μF/50V	680μF/100V
C1, C3	4.7μF/50V	4.7μF/100V
C2	330μF/50V	330μF/100V
C4	Refer to the Cout in Fig.2	
LCM	2.2mH, recommended to use MORNSUN's FL2D-30-222	
CY1, CY2	2.2nF/2KV	

3. Trim function for output voltage adjustment (open if unused)

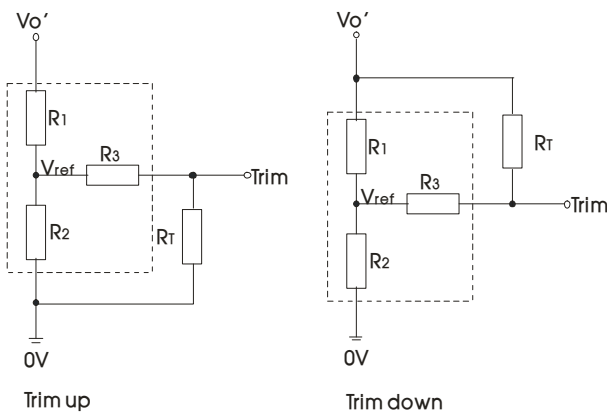

Calculation formula of Trim resistance:

$$\begin{aligned} \text{up: } R_T &= \frac{\alpha R_2}{R_2 - \alpha} - R_3 & \alpha &= \frac{V_{ref}}{V_{o'} - V_{ref}} \cdot R_1 \\ \text{down: } R_T &= \frac{\alpha R_1}{R_1 - \alpha} - R_3 & \alpha &= \frac{V_{o'} - V_{ref}}{V_{ref}} \cdot R_2 \end{aligned}$$

R_T = Trim Resistor value;
 α = self-defined parameter
 $V_{o'}$ = desired output voltage

TRIM resistor connection (dashed line shows internal resistor network)

Vout(VDC)	R1(KΩ)	R2(KΩ)	R3(KΩ)	Vref(V)
05	2.880	2.87	10	2.5
12	11.000	2.87	15	2.5
15	14.494	2.87	15	2.5
24	24.872	2.87	15	2.5

- The products do not support parallel connection of their output
- For additional information please refer to DC-DC converter application notes on www.mornsun-power.com

VRB_LD-40WR3 Dimensions and Recommended Layout

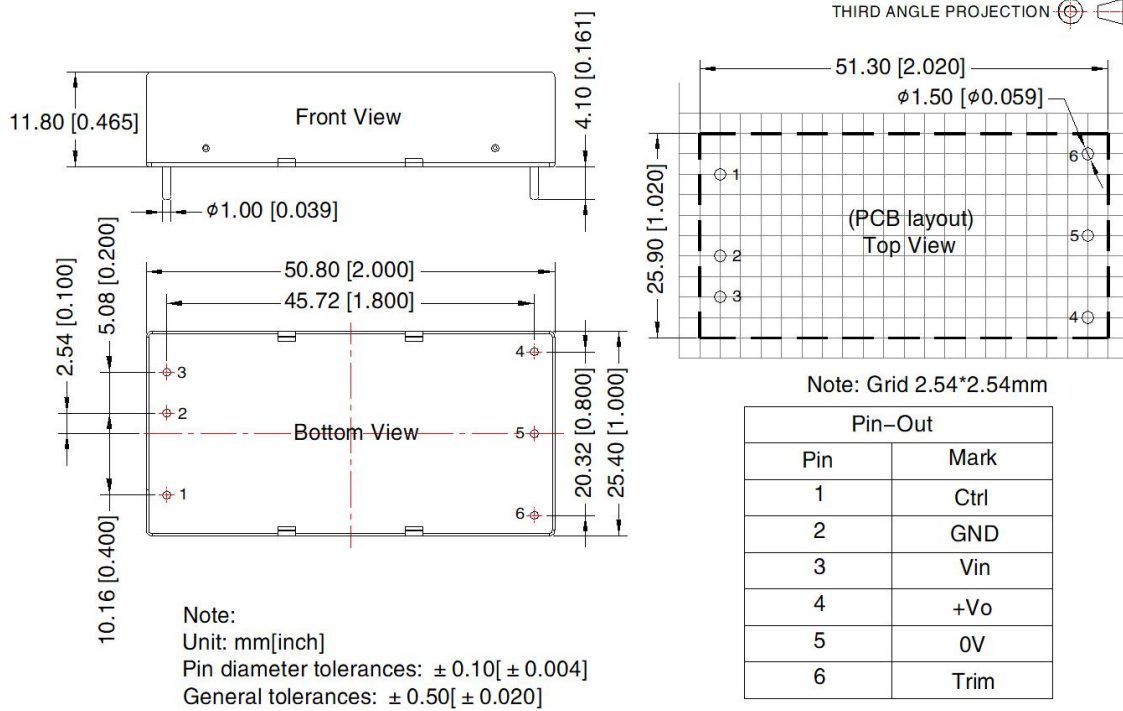

VRB_LD-40WR3A2S Dimensions and Recommended Layout

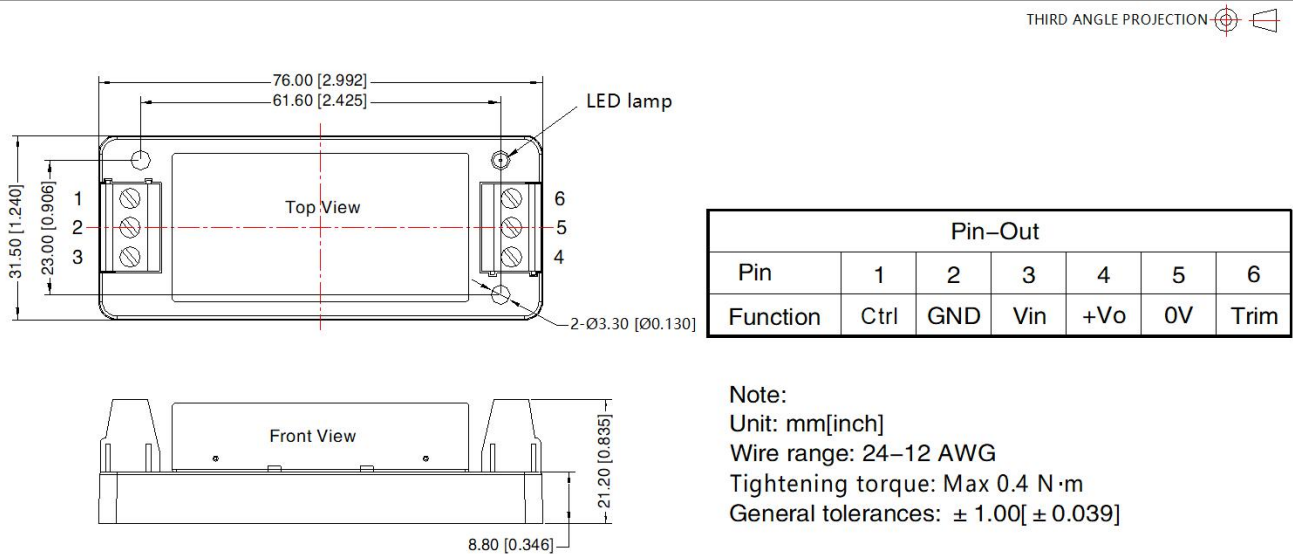

VRB_LD-40WR3A4S Dimensions and Recommended Layout

THIRD ANGLE PROJECTION

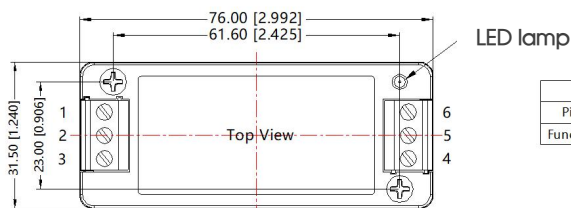

		Pin-Out					
Pin		1	2	3	4	5	6
Function		Ctrl	GND	Vin	+Vo	0V	Trim

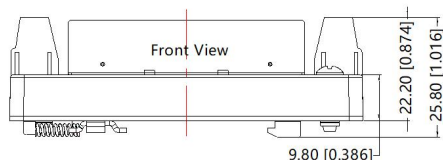

Note:
Unit: mm[inch]
Mounting rail: TS35
Wire range: 24-12 AWG
Tightening torque: Max 0.4 N·m
General tolerances: ±1.00[±0.039]

VRB_LD-40WHR3 Dimensions and Recommended Layout

THIRD ANGLE PROJECTION

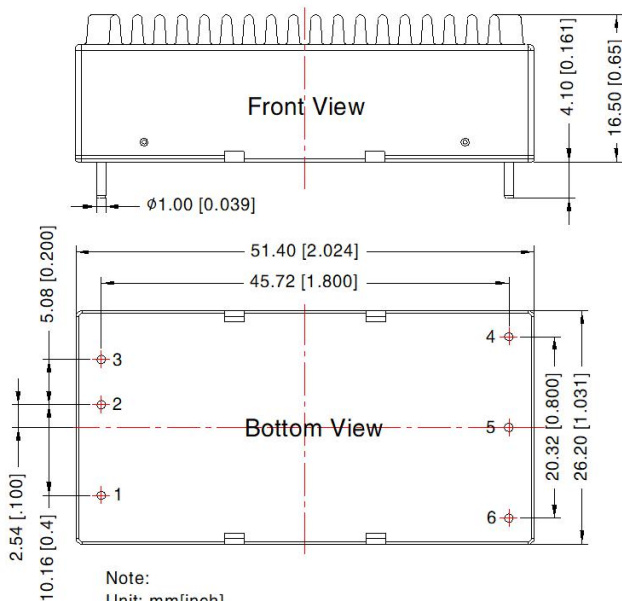

Note:
Unit: mm[inch]
Pin diameter tolerances: ± 0.10[± 0.004]
General tolerances: ± 0.50[± 0.020]

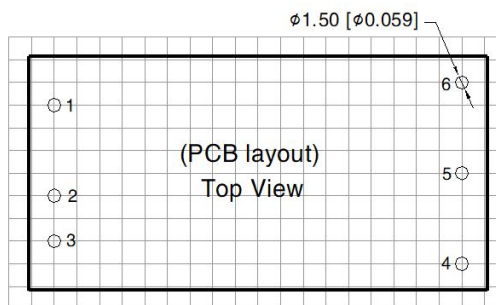

Note: Grid 2.54*2.54mm

		Pin-Out	
Pin		Mark	
1		Ctrl	
2		GND	
3		Vin	
4		+Vo	
5		0V	
6		Trim	

VRB_LD-40WHR3A2S Dimensions and Recommended Layout

THIRD ANGLE PROJECTION 

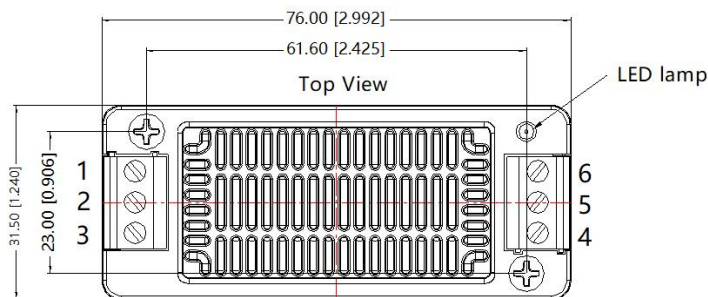

Pin-Out						
Pin	1	2	3	4	5	6
Function	Ctrl	GND	Vin	+Vo	0V	Trim

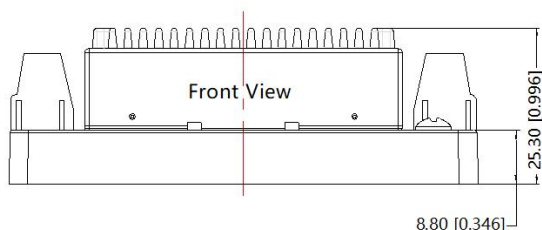

Note:
Unit: mm[inch]
Mounting rail: TS35
Wire range: 24-12 AWG
Tightening torque: Max 0.4 N·m
General tolerances: ±1.00[±0.039]

VRB_LD-40WHR3A4S Dimensions and Recommended Layout

THIRD ANGLE PROJECTION 

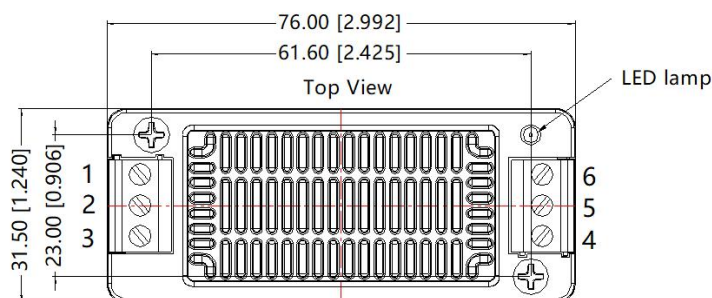

Pin-Out						
Pin	1	2	3	4	5	6
Function	Ctrl	GND	Vin	+Vo	0V	Trim

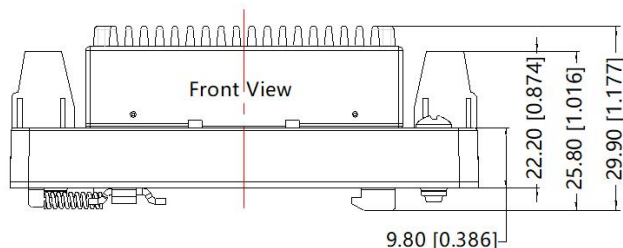

Note:
Unit: mm[inch]
Mounting rail: TS35
Wire range: 24-12 AWG
Tightening torque: Max 0.4 N·m
General tolerances: ±1.00[±0.039]

Notes:

1. For additional information on Product Packaging please refer to www.mornsun-power.com. Packaging bag number: 58200035(without heat sink); 58200051(with heat sink); 58220022(A2S/A4S);
2. The maximum capacitive load offered were tested at input voltage range and full load;
3. Unless otherwise specified, parameters in this datasheet were measured under the conditions of $T_a=25^{\circ}\text{C}$, humidity<75%RH with nominal input voltage and rated output load;
4. All index testing methods in this datasheet are based on company corporate standards;
5. We can provide product customization service, please contact our technicians directly for specific information;
6. Products are related to laws and regulations: see "Features" and "EMC";
7. Our products shall be classified according to ISO14001 and related environmental laws and regulations, and shall be handled by qualified units.

Mornsun Guangzhou Science & Technology Co., Ltd.

Address: No. 5, Kehui St. 1, Kehui Development Center, Science Ave., Guangzhou Science City, Huangpu District, Guangzhou, P. R. China
Tel: 86-20-38601850 Fax: 86-20-38601272 E-mail: info@mornsun.cn www.mornsun-power.com