

15 & 20W isolated DC-DC converter with Ultra-wide Input and Regulated Single Output

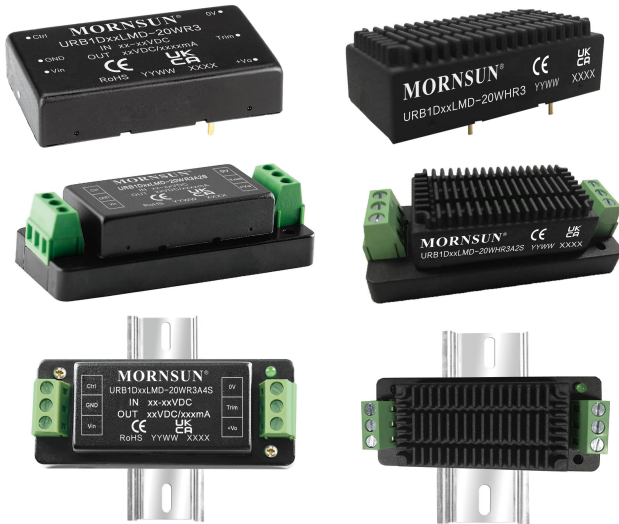

Patent Protection

UL62368-1
 EN62368-1/EN60950-1 EN50155
 BS EN62368-1
 IEC62368-1
 RoHS

FEATURES

- Ultra-wide 4:1 input voltage range
- Reinforced I/O isolation test voltage 2.25k VDC
- Operating ambient temperature range -40°C to +85°C
- Input under-voltage protection, output short circuit, over-current, over-voltage protection
- Low output Ripple & Noise
- CLSPR32/EN55032 CLASS A EMI compliant without external components
- Input Reverse Polarity Protection available with Chassis (A2S) or 35mm DIN-Rail mounting (A4S) version
- Industry standard pin-out

URB1D_LMD-15W(H)R3 15W and URB1D_LMD-20W(H)R3 20W series of isolated DC-DC converter products have an ultra-wide 4:1 input voltage and feature efficiencies of up to 86%. Input to output isolation is tested with 2250VDC and the converters safely operate in an ambient temperature of -40°C to +85°C and are offered with various mounting options ideally suiting electronic equipment and railway vehicle applications using 72V, 96V and 110V battery voltages. The modules are fully featured, protected and include remote On/Off and Trim function for output voltage adjustment.

Selection Guide

Certification ^①	Part No. ^②	Input Voltage (VDC)		Output		Full Load Efficiency ^④ (%) Min./Typ.	Capacitive Load(μF) Max.
		Nominal (Range)	Max. ^③	Voltage (VDC)	Current(mA) Max./Min.		
EN/BS EN	URB1D03LMD-15WR3	110 (40-160)	170	3.3	4000/0	80/82	5400
	URB1D05LMD-15WR3			5	3000/0	82/84	5400
UL/EN/BS EN/IEC	URB1D12LMD-15WR3			12	1250/0	82/84	1000
EN/BS EN	URB1D15LMD-15WR3			15	1000/0	83/85	820
UL/EN/BS EN/IEC	URB1D24LMD-15WR3			24	625/0	83/85	270
EN/BS EN	URB1D03LMD-20WR3			3.3	5000/0	80/82	10000
	URB1D05LMD-20WR3			5	4000/0	82/84	10000
	URB1D12LMD-20WR3			12	1667/0	83/85	1600
	URB1D15LMD-20WR3	15	1333/0	84/86	1000		
UL/EN/BS EN/IEC	URB1D24LMD-20WR3	24	833/0	84/86	470		

Note:
 ①URB1D_LMD-15W(H)R3 series CE certification standards for EN62368-1 and EN50155; RB1D_LMD-20W(H)R3 series CE certification standards for EN60950-1 and EN50155;
 ②Use "H" suffix for heat sink mounting, "A2S" suffix for chassis mounting and "A4S" suffix for DIN-Rail mounting. We recommend to choose modules with a heat sink for enhanced heat dissipation and applications with extreme temperature requirements;
 ③Absolute maximum stress rating without damage (not recommended);
 ④Efficiency is measured at nominal input voltage and rated output load; efficiencies for A2S and A4S Model's is decreased by 2% due to the input reverse polarity protection circuit.

Input Specifications

Item	Operating Conditions	Min.	Typ.	Max.	Unit	
Input Current (full load / no-load)	URB1D_LMD-15WR3 series, Nominal input voltage	3.3V output	--	147/10	150/20	mA
		5V output	--	163/10	167/20	
		Others	--	159/3	166/8	

Input Current (full load / no-load)	URB1D_LMD-20WR3 series, Nominal input voltage	3.3V output	--	183/10	188/20	mA
		5V output	--	217/10	222/20	
		Others	--	214/3	219/8	
Reflected Ripple Current	Nominal input voltage	--	25	--		
Surge Voltage (1sec. max.)		-0.7	--	180		
Start-up Voltage	100% load	--	--	40		VDC
Input Under-voltage Protection		28	33	--		
Start-up Time	Nominal input voltage & constant resistance load	--	10	--		ms
Input Filter		Pi filter				
Hot Plug		Unavailable				
Ctrl *	Module on	Ctrl pin open or pulled high (3.5-12VDC)				
	Module off	Ctrl pin pulled low to GND (0-1.2VDC)				
	Input current when off	--	2	7		mA

Note: *The Ctrl pin voltage is referenced to input GND.

Output Specifications

Item	Operating Conditions	Min.	Typ.	Max.	Unit	
Voltage Accuracy	0%-100% load	--	±1	±3	%	
Linear Regulation	Input voltage variation from low to high at full load	--	±0.2	±0.5		
Load Regulation	0%-100% load	--	±0.5	±1		
Transient Recovery Time	25% load step change, nominal input voltage	--	300	500	μs	
Transient Response Deviation	25% load step change, nominal input voltage	3.3V/5V output	--	±3	±8	%
		Others	--	±3	±5	
Temperature Coefficient	Full load	--	±0.02	±0.03	%/°C	
Ripple & Noise *	20MHz bandwidth, 5%-100% load	--	50	100	mV p-p	
Trim		90	--	110	%Vo	
Over-voltage Protection		110	--	160		
Over-current Protection	Input voltage range	120	--	210	%Io	
Short-circuit Protection		Continuous, self-recovery				

Note: *Under 0% -5% load conditions, ripple & noise does not exceed 5%Vo. The "parallel cable" method is used for Ripple and Noise test, please refer to DC-DC Converter Application Notes for specific information.

General Specifications

Item	Operating Conditions	Min.	Typ.	Max.	Unit
Isolation	Input-output Electric Strength Test for 1 minute with a leakage current of 1mA max.	2250	--	--	VDC
	Input/output-case Electric Strength Test for 1 minute with a leakage current of 1mA max.	1600	--	--	
Insulation Resistance	Input-output resistance at 500VDC	1000	--	--	MΩ
Isolation Capacitance	Input-output capacitance at 100kHz/0.1V	--	2200	--	pF
Operating Temperature	See Fig. 1	-40	--	+85	°C
Storage Temperature		-55	--	+125	
Storage Humidity	Non-condensing	5	--	95	%RH
Pin Soldering Resistance Temperature	Soldering spot is 1.5mm away from case for 10 seconds	--	--	300	°C
Switching Frequency *	PWM mode	--	300	--	kHz
Shock & Vibration test		IEC61373 - Category 1, Grade B			
MTBF	MIL-HDBK-217F@25°C	1000	--	--	k hours

Note: *Switching frequency is measured at full load. The module reduces the switching frequency for light load (below 50%) efficiency improvement.

Mechanical Specifications

Case Material	Aluminum alloy		
Dimensions	Without heat sink	Horizontal package	50.80 x 25.40 x 11.80mm
		A2S chassis mounting	76.00 x 31.50 x 21.20 mm
		A4S Din-rail mounting	76.00 x 31.50 x 25.80 mm
Dimensions	With heat sink	Horizontal package	51.40 x 26.20 x 16.50mm
		A2S chassis mounting	76.00 x 31.50 x 25.30 mm
		A4S Din-rail mounting	76.00 x 31.50 x 29.90 mm
Weight	Without heat sink	Horizontal package/A2S chassis mounting/A4S Din-rail mounting	26.0g/48.0g/68.0g(Typ.)
	With heat sink	Horizontal package/A2S chassis mounting/A4S Din-rail mounting	34.0g/56.0g/76.0g(Typ.)
Cooling Method	Free air convection		

Electromagnetic compatibility (EMC) (EN60950)

Emissions	CE	CISPR32/EN55032	CLASS A(see Fig.3 for recommended circuit)/ CLASS B(see Fig.5-② for recommended circuit)	
	RE	CISPR32/EN55032	CLASS A(without external components)/ CLASS B (see Fig.5-② for recommended circuit)	
Immunity	ESD	IEC/EN61000-4-2	Contact ±6kV/Air ±8kV	perf. Criteria B
	RS	IEC/EN61000-4-3	10V/m	perf. Criteria A
	EFT	IEC/EN61000-4-4	±4kV (see Fig.4 or Fig.5-① for recommended circuit)	perf. Criteria B
	Surge	IEC/EN61000-4-5	line to line ±2kV (2Ω 18uF see Fig.4 for recommended circuit)	perf. Criteria B
			line to ground ±4kV (12Ω 9uF see Fig.4 for recommended circuit)	perf. Criteria B
	Surge	EN50121-3-2	line to line ±1kV (42Ω 0.5uF see Fig.5-① for recommended circuit)	perf. Criteria B
line to ground ±2kV (42Ω 0.5uF see Fig.5-① for recommended circuit)			perf. Criteria B	
CS	IEC/EN61000-4-6	10 Vr.m.s	perf. Criteria A	

Electromagnetic Compatibility (EMC) (EN50155)

Emissions	CE	EN50121-3-2 EN55016-2-1	150kHz-500kHz 99dBuV 500kHz-30MHz 93dBuV	
	RE	EN50121-3-2 EN55016-2-1	30MHz-230MHz 40dBuV/m at 10m 230MHz-1GHz 47dBuV/m at 10m	
Immunity	ESD	EN50121-3-2	Contact ±6kV/Air ±8kV	perf. Criteria B
	RS	EN50121-3-2	20V/m	perf. Criteria A
	EFT	EN50121-3-2	±2kV 5/50ns 5kHz	perf. Criteria A
	Surge	EN50121-3-2	line to line ±1kV (42Ω, 0.5 μF)	perf. Criteria B
			line to ground ±2kV (42Ω, 0.5 μF)	perf. Criteria B
CS	EN50121-3-2	0.15MHz-80MHz 10 Vr.m.s	perf. Criteria A	

Note: All the tests are measured under the conditions of inputs capacitor 100uF/200V or FC-CX1D filter (the recommended circuit please see Fig.3 or see Fig.4).

Typical Characteristic Curves

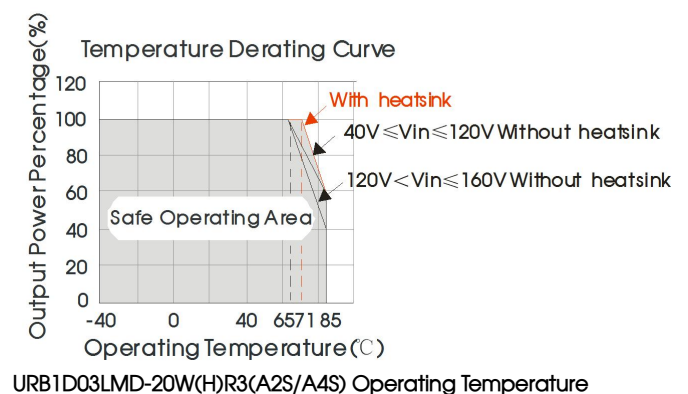
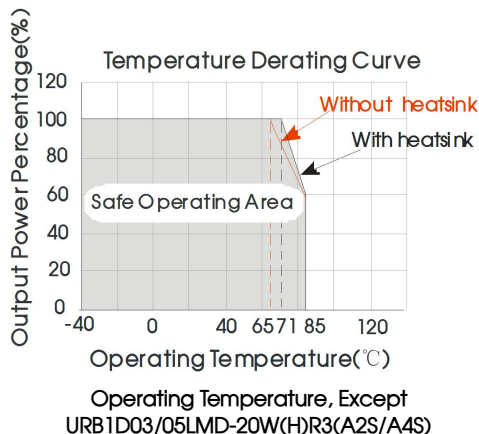

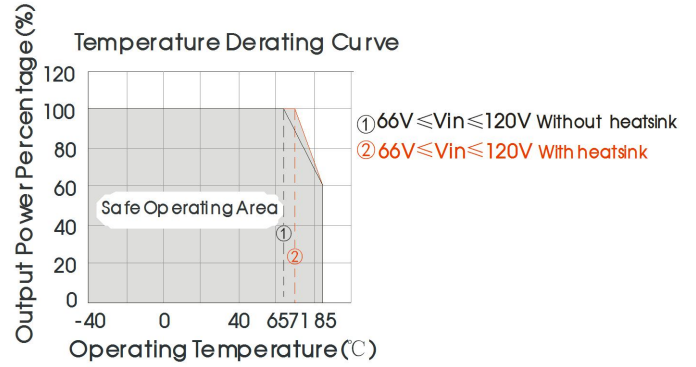
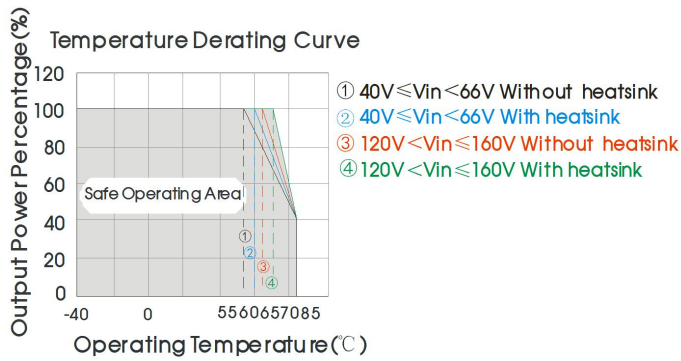

URB1D05LMD-20W(H)R3(A2S/A4S) Operating Temperature
Fig. 1

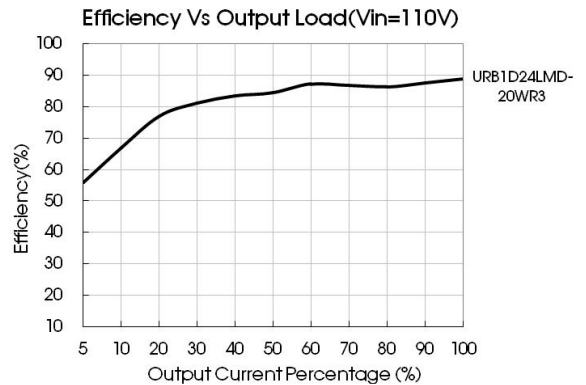
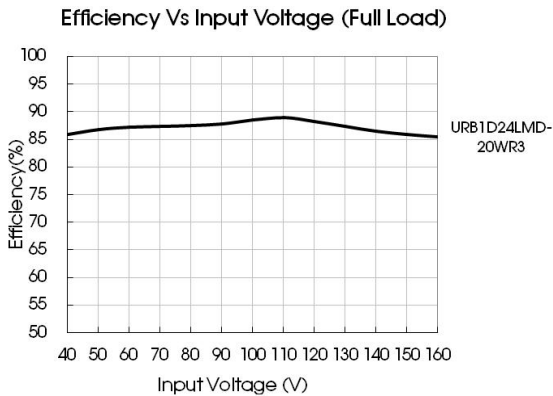
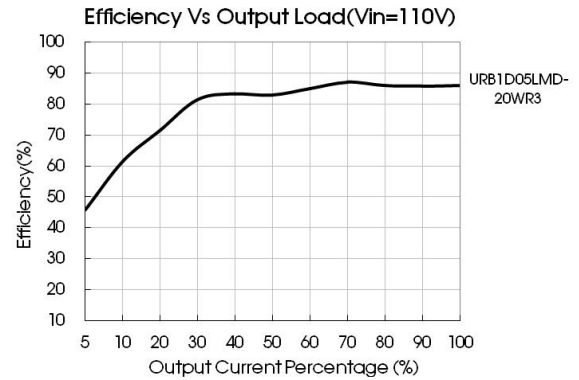
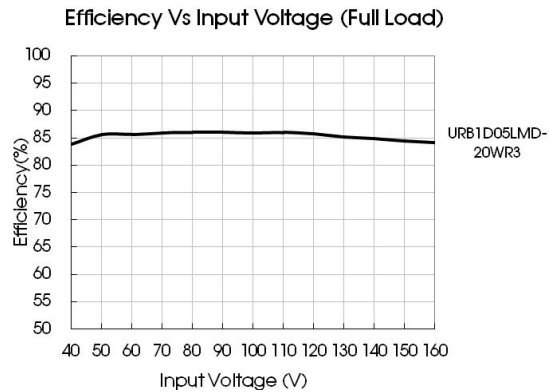

Design Reference

1. Typical application

All the DC-DC converters of this series are tested before delivery using the recommended circuit shown in Fig. 2.

Input and/or output ripple can be further reduced by appropriately increasing the input & output capacitor values C_{in} and C_{out} and/or by selecting capacitors with a low ESR (equivalent series resistance). Also make sure that the capacitance is not exceeding the max. capacitive load value of the product.

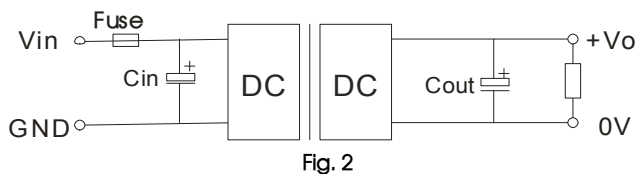

Vout(VDC)	Fuse	Cin	Cout
3.3/5	2A, slow blow	10 μ F - 47 μ F/250V	470 μ F/16V
12/15			220 μ F/25V
24			100 μ F/50V

2. EMC compliance circuit



Fig. 3

Notes: Fig. 3 Cin please use the 250V withstand voltage of the capacitor.

Fig. 3 List of components:

Cin	27uF -100μF/250V
Cout	Refer to the Cout in Fig.2

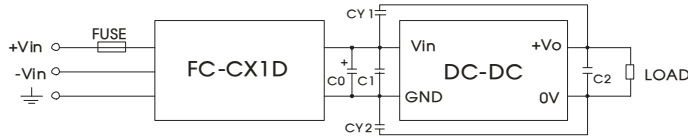

Fig. 4

Fig. 4 List of components:

FUSE	Choose according to actual input current
FC-CX1D	FC-CX1D: Mornsun EMC filter, Input voltage range: 40V-160V
C0	100μF/200V
C1	Refer to the Cin in Fig.2
C2	Refer to the Cout in Fig.2
CY1, CY2	1000pF/400VAC

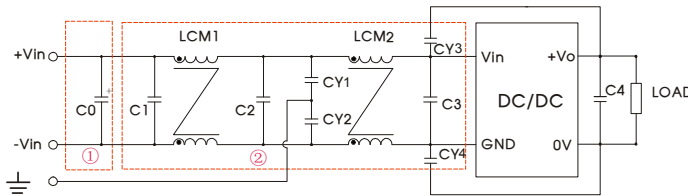

Fig. 5

Notes: Part ① in the Fig. 5 is used for EMS test and part ② for EMI test

Fig. 5 List of components:

Model	URB1D_LMD-15WR3	URB1D_LMD-20WR3
C0	100μF/200V	
C1, C2	0.22μF/250V	
C3	Refer to the Cin in Fig.2	
LCM1	15mH (UU common mode inductance)	2.2mH(FL2D-10-222)
LCM2	15mH (UU common mode inductance)	0.53mH (material: TN150P-RH12.7*12.7*7.9)
CY1, CY2, CY3, CY4	1000pF/400VAC	
C4	Refer to the Cout in Fig.2	

Notes: FL2D-10-222: Mornsun common mode filter.

3. Trim Function for Output Voltage Adjustment (open if unused)

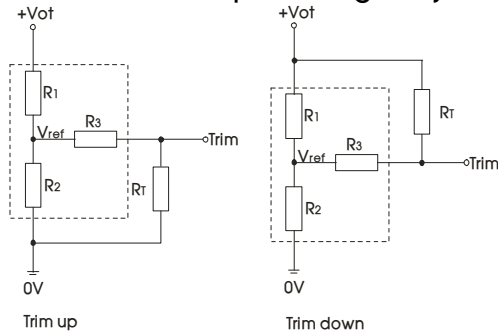

TRIM resistor connection (dashed line shows internal resistor network)

Calculating Trim resistor values:

$$\begin{aligned} \text{up: } R_T &= \frac{\alpha R_2}{R_2 - \alpha} - R_3 & \alpha &= \frac{V_{ref}}{V_o' - V_{ref}} \cdot R_1 \\ \text{down: } R_T &= \frac{\alpha R_1}{R_1 - \alpha} - R_3 & \alpha &= \frac{V_o' - V_{ref}}{V_{ref}} \cdot R_2 \end{aligned}$$

R_T = Trim Resistor value;
α = self-defined parameter
V_o' = desired output voltage

Vout(V)	R1(kΩ)	R2(kΩ)	R3(kΩ)	Vref(V)
3.3	4.772	2.87	10	1.25
5	2.883	2.87	10	2.5
12	11.000	2.87	15	2.5
15	14.384	2.87	15	2.5
24	24.872	2.87	17.8	2.5

4. The products do not support parallel connection of their output

5. For additional information please refer to DC-DC converter application notes on www.mornsun-power.com

Horizontal Package (without heat sink) Dimensions and Recommended Layout

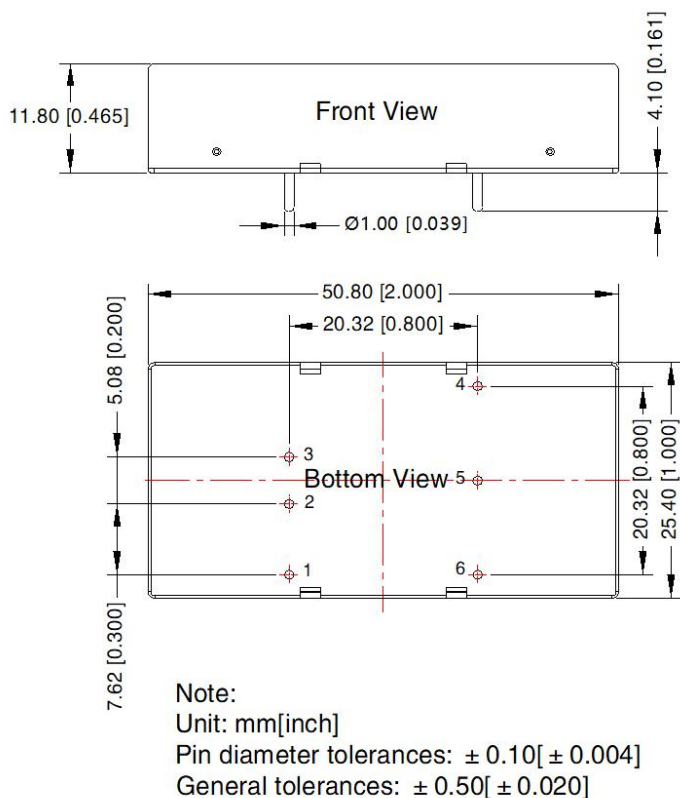

THIRD ANGLE PROJECTION

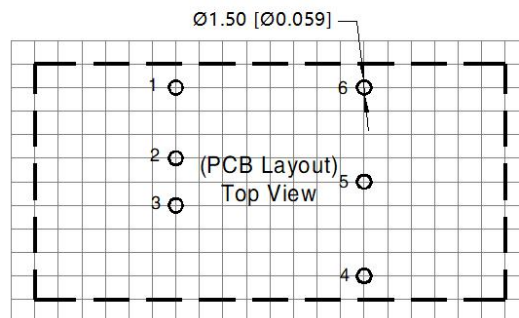

Pin-Out	
Pin	Mark
1	Ctrl
2	GND
3	Vin
4	+Vo
5	Trim
6	0V

Horizontal Package (with heatsink) Dimensions

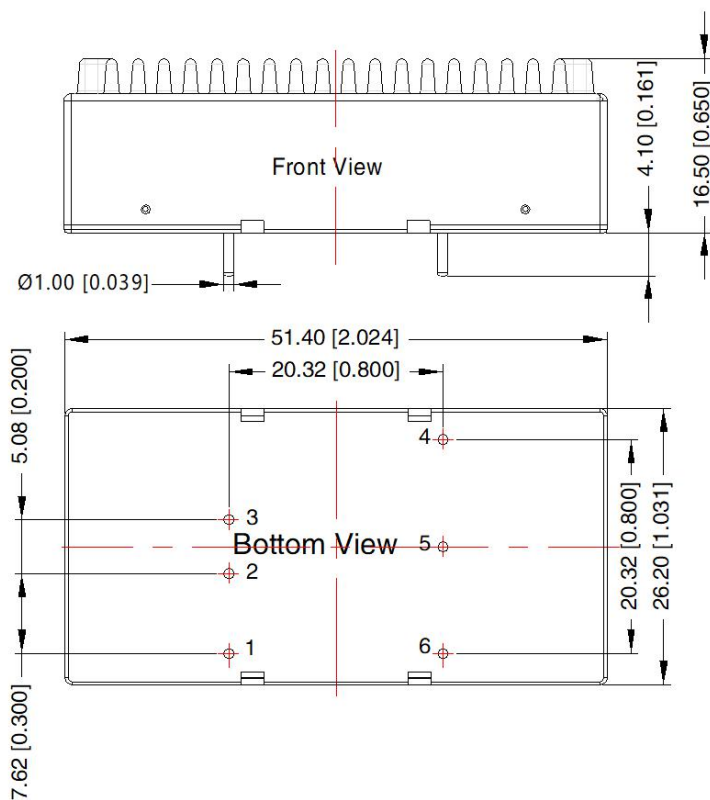

THIRD ANGLE PROJECTION

Pin-Out	
Pin	Mark
1	Ctrl
2	GND
3	Vin
4	+Vo
5	Trim
6	0V

Note:
Unit: mm[inch]
General tolerances: ± 0.50 [± 0.020]

URB1D_LMD-15WR3A2S & URB1D_LMD-20WR3A2S (without heatsink) Dimensions

THIRD ANGLE PROJECTION 

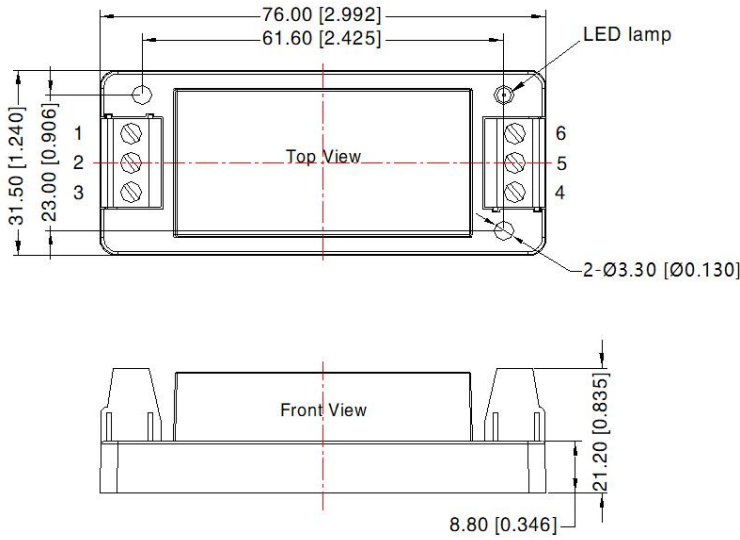

Pin-Out						
Pin	1	2	3	4	5	6
Mark	Ctrl	GND	Vin	+Vo	Trim	0V

Note:
 Unit: mm[inch]
 Wire range: 24-12 AWG
 Tightening torque: Max 0.4 N·m
 General tolerances: ± 1.00 [± 0.039]

URB1D_LMD-15WHR3A2S & URB1D_LMD-20WHR3A2S (with heatsink) Dimensions

THIRD ANGLE PROJECTION 

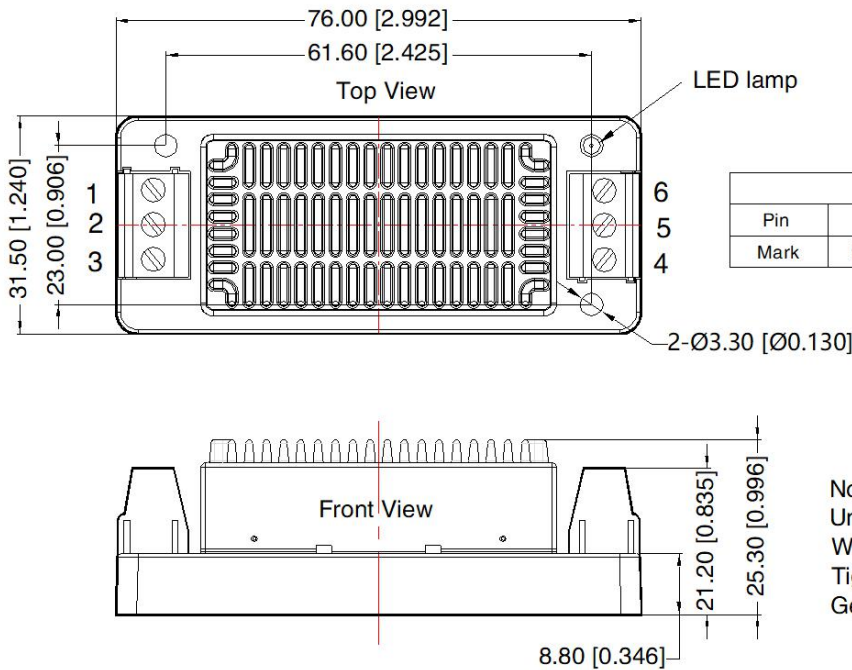

Pin-Out						
Pin	1	2	3	4	5	6
Mark	Ctrl	GND	Vin	+Vo	Trim	0V

Note:
 Unit: mm[inch]
 Wire range: 24-12 AWG
 Tightening torque: Max 0.4 N·m
 General tolerances: ± 1.00 [± 0.039]

URB1D_LMD-15WR3A4S & URB1D_LMD-20WR3A4S (without heatsink) Dimensions

THIRD ANGLE PROJECTION 

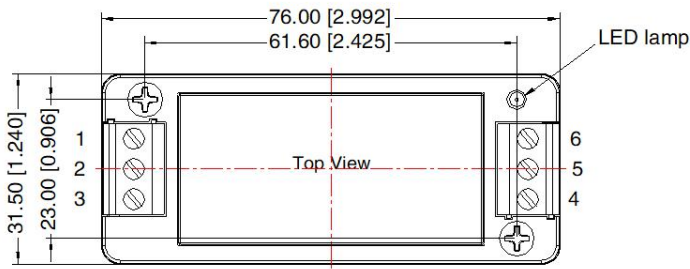

Pin-Out						
Pin	1	2	3	4	5	6
Mark	Ctrl	GND	Vin	+Vo	Trim	0V

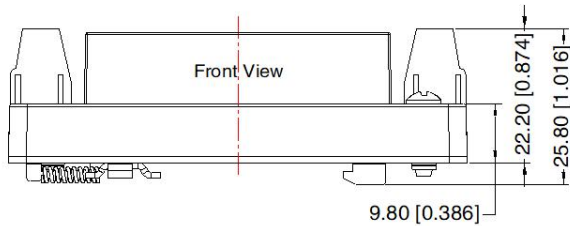

Note:
 Unit: mm[inch]
 Mounting rail: TS35
 Wire range: 24-1.
 Tightening torque: Max 0.4 N·m
 General tolerances: ± 1.00[± 0.039]

URB1D_LMD-15WHR3A4S & URB1D_LMD-20WHR3A4S (with heatsink) Dimensions

THIRD ANGLE PROJECTION 

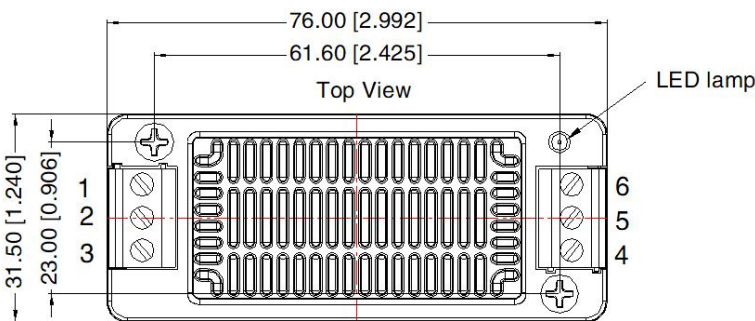

Pin-Out						
Pin	1	2	3	4	5	6
Mark	Ctrl	GND	Vin	+Vo	Trim	0V

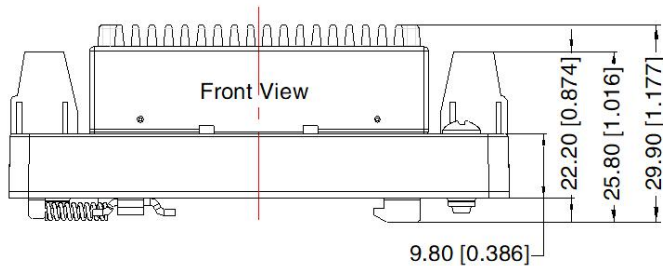

Note:
 Unit: mm[inch]
 Mounting rail: TS35
 Wire range: 24-12 AWG
 Tightening torque: Max 0.4 N·m
 General tolerances: ± 1.00[± 0.039]

Note:

1. For additional information on Product Packaging please refer to www.mornsun-power.com. The Packaging bag number of Horizontal packaging: 58200035(without heat sink), 58200051(with heat sink), A2S/ A4S packaging number: 58220022;
2. The maximum capacitive load offered were tested at input voltage range and full load;
3. Unless otherwise specified, parameters in this datasheet were measured under the conditions of $T_a=25^{\circ}\text{C}$, humidity<75%RH with nominal input voltage and rated output load;
4. All index testing methods in this datasheet are based on company corporate standards;
5. Other product application information, please see DC-DC (railway power supply) Converter Application Notes for specific operation methods;
6. We can provide product customization service, please contact our technicians directly for specific information;
7. Products are related to laws and regulations: see "Features" and "EMC";
8. Our products shall be classified according to ISO14001 and related environmental laws and regulations, and shall be handled by qualified units.

Mornsun Guangzhou Science & Technology Co., Ltd.

Address: No. 5, Kehui St. 1, Kehui Development Center, Science Ave., Guangzhou Science City, Huangpu District, Guangzhou, P. R. China
Tel: 86-20-38601850 Fax: 86-20-38601272 E-mail: info@mornsun.cn www.mornsun-power.com