

20W isolated DC-DC converter with Ultra-wide Input and Regulated Single Output

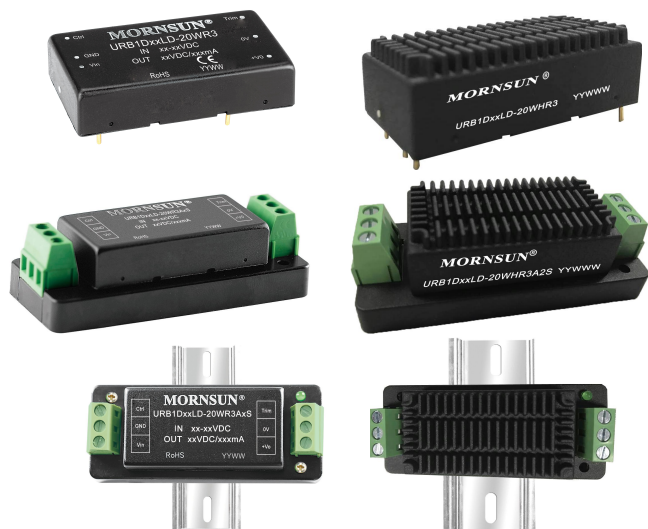

## FEATURES

- Ultra-wide 4:1 input voltage range
- Reinforced I/O isolation test voltage 2.25k VDC
- Operating ambient temperature range -40°C to +85°C
- Input under-voltage protection, output short circuit, over-current, over-voltage protection
- Low output ripple & noise
- EN50121-3-2 & CISPR32/EN55032 CLASS A EMI compliant without external components
- EN50155/EN60950 Approval
- Designed to meet IEC60950/UL60950 safety standards
- Input Reverse Polarity Protection available with Chassis (A2S) or 35mm DIN-Rail mounting (A4S) version
- Industry standard pin-out



Patent Protection RoHS



URB1D\_LD-20WR3 20W series of isolated DC-DC converter products have an ultra-wide 4:1 input voltage and feature efficiencies of up to 87%. Input to output isolation is tested with 2250VDC and the converters safely operate in an ambient temperature of -40°C to +85°C, input under-voltage protection, output short circuit, over-current, over-voltage protection and are offered with various mounting options ideally suiting electronic equipment and railway vehicle applications using 72V, 96V and 110V battery voltages.

## Selection Guide

Certification	Part No. <sup>①</sup>	Input Voltage (VDC)		Output		Full Load Efficiency <sup>③</sup> (%) Min./Typ.	Max. Capacitive Load(μF)
		Nominal (Range)	Max. <sup>②</sup>	Voltage (VDC)	Current(mA) Max./Min.		
CE	URB1D03LD-20WR3	110 (40-160)	170	3.3	5000/0	80/82	10000
	URB1D05LD-20WR3			5	4000/0	83/85	10000
	URB1D12LD-20WR3			12	1667/0	84/86	1600
	URB1D15LD-20WR3			15	1333/0	84/86	1000
	URB1D24LD-20WR3			24	833/0	85/87	470

Note:

- ① Use "H" suffix for heat sink mounting, "A2S" suffix for chassis mounting and "A4S" suffix for DIN-Rail mounting. We recommend to choose modules with a heat sink for enhanced heat dissipation and applications with extreme temperature requirements;
- ② Absolute maximum stress rating without damage (not recommended);
- ③ Efficiency is measured at nominal input voltage and rated output load; efficiencies for A2S and A4S Model's is decreased by 2% due to the input reverse polarity protection circuit.

Input Specifications

Item	Operating Conditions		Min.	Typ.	Max.	Unit
Input Current (full load / no-load)	Nominal input voltage	3.3V output	--	183/10	188/20	mA
		5V output	--	214/10	219/20	
		Others	--	212/3	217/8	
Reflected Ripple Current	Nominal input voltage		--	25	--	VDC
Surge Voltage (1sec. max.)			-0.7	--	180	
Start-up Voltage	100% load		--	--	40	
Shut-down Voltage			28	33	--	
Start-up Time	Nominal input voltage & constant resistance load		--	10	--	ms
Input Filter			Pi filter			
Hot Plug			Unavailable			
Ctrl*	Module on		Ctrl pin open or pulled high (3.5-12VDC)			
	Module off		Ctrl pin pulled low to GND (0-1.2VDC)			
	Input current when off		--	2	7	mA

Note: \*The Ctrl pin voltage is referenced to input GND.

Output Specifications

Item	Operating Conditions		Min.	Typ.	Max.	Unit
Voltage Accuracy	0% -100% load		--	±1	±3	%
Linear Regulation	Input voltage variation from low to high at full load		--	±0.2	±0.5	
Load Regulation	0% -100% load		--	±0.5	±1	
Transient Recovery Time			--	300	500	μs
Transient Response Deviation	25% load step change, nominal input voltage	3.3V/5V output	--	±3	±8	%
		Others	--	±3	±5	
Temperature Coefficient	Full load		--	±0.02	±0.03	%/°C
Ripple & Noise *	20MHz bandwidth, 5% -100% load		--	50	100	mV p-p
Trim			90	--	110	%Vo
Over-voltage Protection			110	--	160	
Over-current Protection	Input voltage range		120	--	210	%Io
Short-circuit Protection			Continuous, self-recovery			

Note: \*Ripple & Noise at < 5% load is 5%Vo max. The "parallel cable" method is used for Ripple and Noise test, please refer to DC-DC Converter Application Note for specific information.

General Specifications

Item	Operating Conditions	Min.	Typ.	Max.	Unit
Isolation	Input-output Electric Strength Test for 1 minute with a leakage current of 1mA max.	2250	--	--	VDC
	Input/output-case Electric Strength Test for 1 minute with a leakage current of 1mA max.	1600	--	--	
Insulation Resistance	Input-output resistance at 500VDC	1000	--	--	MΩ
Isolation Capacitance	Input-output capacitance at 100KHz/0.1V	--	2200	--	pF
Operating Temperature	See Fig. 1	-40	--	+85	°C
Storage Temperature		-55	--	+125	
Storage Humidity	Non-condensing	5	--	95	%RH
Pin Soldering Resistance Temperature	Soldering spot is 1.5mm away from case for 10 seconds	--	--	300	°C
Switching Frequency*	PWM mode	--	300	--	KHz
Vibration		IEC61373 - Category 1, Grade B			
MTBF	MIL-HDBK-217F@25°C	1000	--	--	K hours

Note: \* Switching frequency is measured at full load. The module reduces the switching frequency for light load (below 50%) efficiency improvement.

Mechanical Specifications

Case Material	Aluminum alloy		
Dimensions	Without heat sink	Horizontal package	50.80 x 25.40 x 11.80mm
		A2S chassis mounting	76.00 x 31.50 x 21.20mm
		A4S Din-rail mounting	76.00 x 31.50 x 25.80mm
	With heat sink	Horizontal package	51.40 x 26.20 x 16.50mm
		A2S chassis mounting	76.00 x 31.50 x 25.30mm
		A4S Din-rail mounting	76.00 x 31.50 x 29.90mm
Weight	Without heat sink	Horizontal package/A2S chassis mounting/A4S Din-rail mounting	26.0g/48.0g/68.0g(Typ.)
	With heat sink	Horizontal package/A2S chassis mounting/A4S Din-rail mounting	34.0g/56.0g/76.0g(Typ.)
Cooling Method	Free air convection		

Electromagnetic compatibility (EMC) (EN60950)

Emissions	CE	CISPR32/EN55032	CLASS A (without external components)/CLASS B (see Fig. 4-② for recommended circuit)	
	RE	CISPR32/EN55032	CLASS A (without external components)/CLASS B (see Fig. 4-② for recommended circuit)	
Immunity	ESD	IEC/EN61000-4-2	Contact ±6KV/Air ±8KV	perf. Criteria B
	RS	IEC/EN61000-4-3	10V/m	perf. Criteria A
	EFT	IEC/EN61000-4-4	±4KV (see Fig.3 or Fig.4-① for recommended circuit)	perf. Criteria B
	Surge	IEC/EN61000-4-5	line to line ±2KV (2Ω 0.5uF see Fig.3 for recommended circuit)	perf. Criteria B
			line to ground ±4KV (12Ω 0.5uF see Fig.3 for recommended circuit)	perf. Criteria B
	EN50121-3-2	line to line ±1KV (42Ω 0.5uF see Fig.4-① for recommended circuit)	perf. Criteria B	
line to ground ±2KV (42Ω 0.5uF see Fig.4-① for recommended circuit)		perf. Criteria B		
CS	IEC/EN61000-4-6	10 Vr.m.s	perf. Criteria A	

Electromagnetic Compatibility (EMC) (EN50155)

Emissions	CE	EN50121-3-2	150kHz-500kHz 99dBuV	
		EN55016-2-1	500kHz-30MHz 93dBuV	
RE	EN50121-3-2	EN55016-2-1	30MHz-230MHz 40dBuV/m at 10m	
		EN55016-2-1	230MHz-1GHz 47dBuV/m at 10m	
Immunity	ESD	EN50121-3-2	Contact ±6KV/Air ±8KV	perf. Criteria B
	RS	EN50121-3-2	20V/m	perf. Criteria A
	EFT	EN50121-3-2	±2kV 5/50ns 5kHz	perf. Criteria A
	Surge	EN50121-3-2	line to line ±1KV (42Ω , 0.5 μ F)	perf. Criteria B
			line to ground ±2KV (42Ω , 0.5 μ F)	perf. Criteria B
CS	EN50121-3-2	0.15MHz-80MHz 10V r.m.s	perf. Criteria A	

Note: All the tests are measured under the conditions of inputs capacitor 100uF/200V or FC-CX1D.

Typical Characteristic Curves

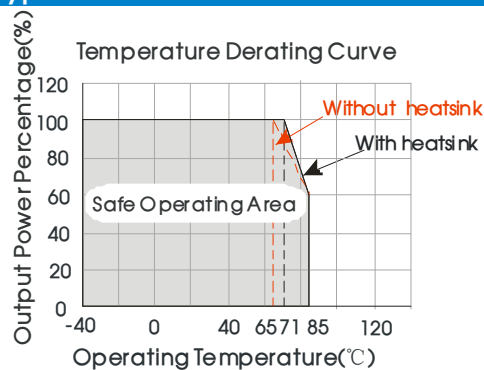

Operating Temperature, Except URB1D03/05LD-20W(H)R3(A2S/A4S)

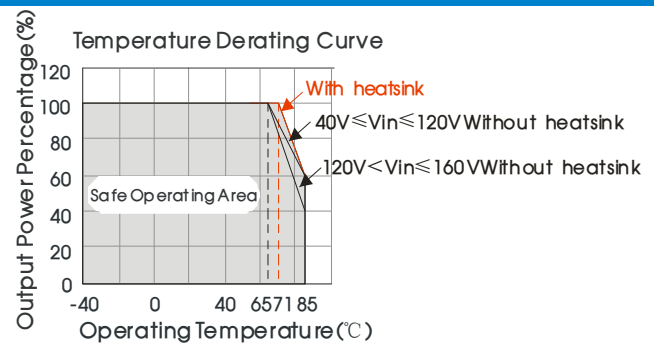

URB1D03LD-20W(H)R3(A2S/A4S) Operating Temperature

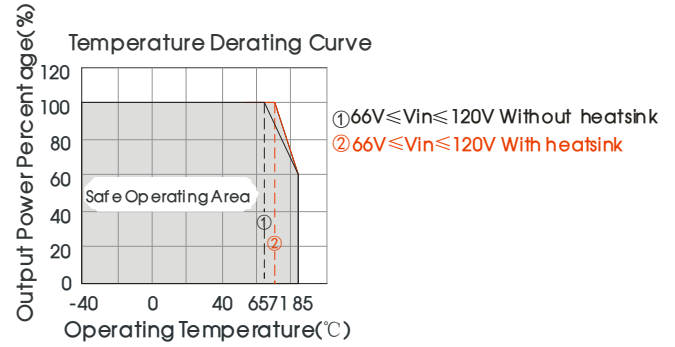
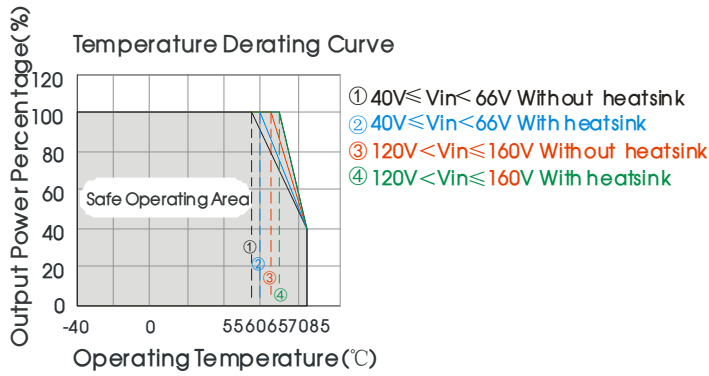

URB1D05LD-20W(H)R3(A2S/A4S) Operating Temperature

Fig. 1

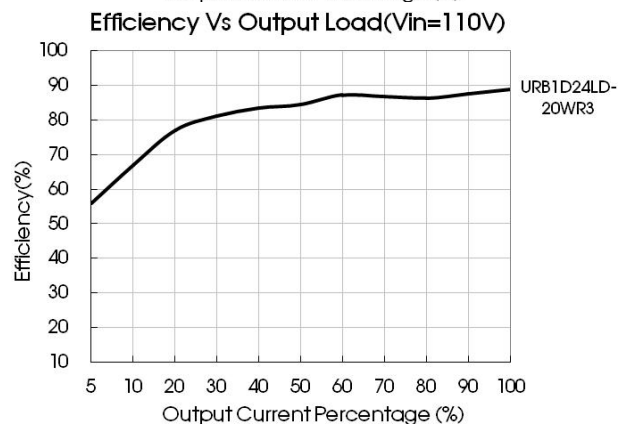
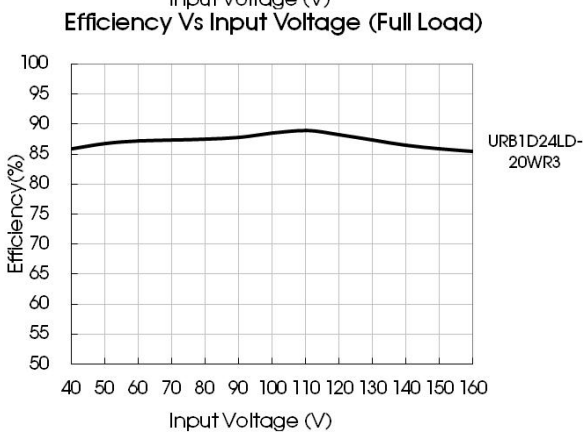
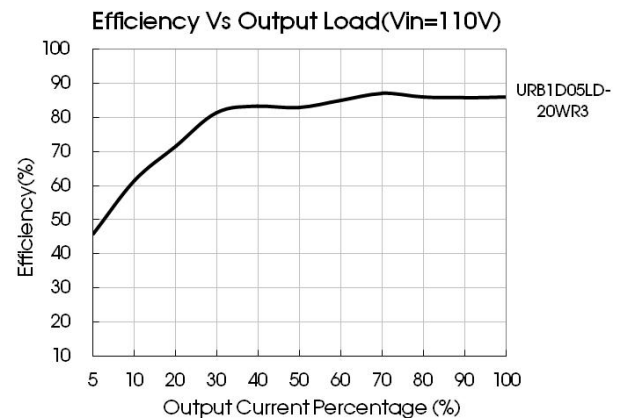
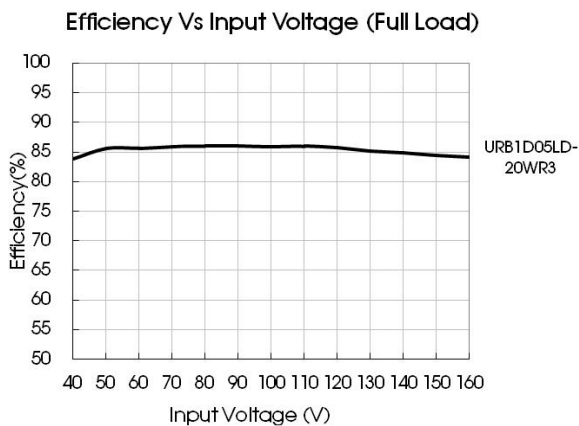

## Design Reference

### 1. Typical application

All DC-DC converters of this series are tested before delivery using the recommended circuit shown in Fig. 2.

Input and/or output ripple can be further reduced by appropriately increasing the input & output capacitor values  $C_{in}$  and  $C_{out}$  and/or by selecting capacitors with a low ESR (equivalent series resistance). Also make sure that the capacitance is not exceeding the max. capacitive load value of the product.

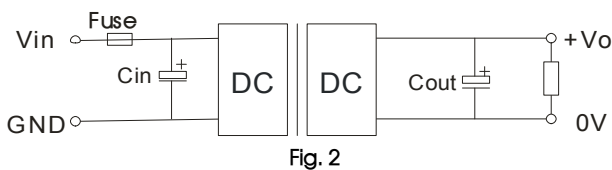

Vout(VDC)	Fuse	Cin	Cout
3.3/5	2A, slow blow	10 $\mu$ F - 47 $\mu$ F	470 $\mu$ F
12/15			220 $\mu$ F
24			100 $\mu$ F

2. EMC compliance circuit

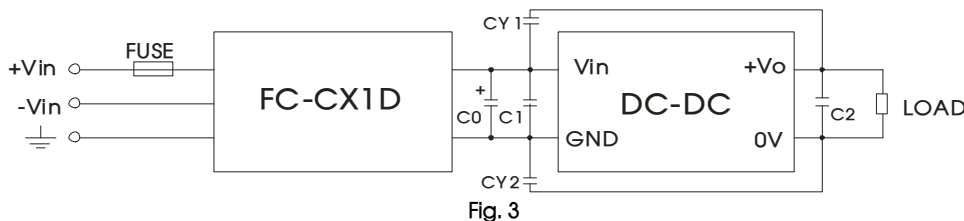

Fig.3 List of components:

Output voltage	3.3V	5V	12V	15V	24V
FUSE	Choose according to actual input current				
FC-CX1D	FC-CX1D is the EMC auxiliary component of our company. Input voltage range: 40V-160V				
C0	100μF/200V				
C1	47μF/200V				
C2	470μF/16V		220μF/25V		100μF/35V
CY1, CY2	1000pF/400VAC				

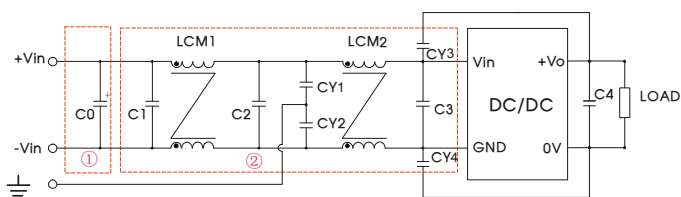

Fig. 4

Notes: Part ① in the Fig. 4 is used for EMS test and part ② for EMI test

Fig.4 List of components:

Output voltage	3.3V	5V	12V	15V	24V
C0	100μF/200V				
C1, C2	0.22μF/250V				
C3	47μF/200V				
LCM1, LCM2	15mH (UU common mode inductance)				
CY1, CY2, CY3, CY4	1000pF/400VAC				
C4	470μF/16V		220μF/25V		100μF/35V

3. Trim Function for Output Voltage Adjustment (open if unused)

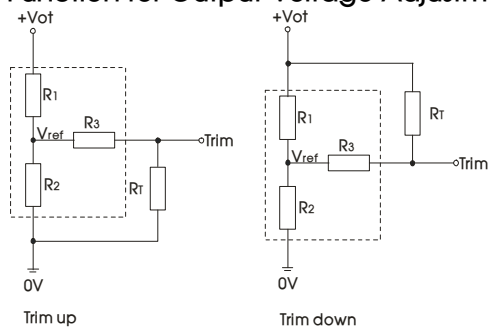

Calculating Trim resistor values:

$$\begin{aligned} \text{up: } R_r &= \frac{\alpha R_2}{R_2 - \alpha} - R_3 & \alpha &= \frac{V_{ref}}{V_o' - V_{ref}} \cdot R_1 \\ \text{down: } R_r &= \frac{\alpha R_1}{R_1 - \alpha} - R_3 & \alpha &= \frac{V_o' - V_{ref}}{V_{ref}} \cdot R_2 \end{aligned}$$

TRIM resistor connection (dashed line shows internal resistor network)

$R_r$  = Trim Resistor value;  $\alpha$  = self-defined parameter;  $V_o'$  = desired output voltage

Vout(V)	R1(KΩ)	R2(KΩ)	R3(KΩ)	Vref(V)
3.3	4.801	2.87	10	1.24
5	2.883	2.87	10	2.5
12	11.000	2.87	15	2.5
15	14.384	2.87	15	2.5
24	24.872	2.87	17.8	2.5

4. The products do not support parallel connection of their output
5. For additional information please refer to DC-DC converter application notes on [www.mornsun-power.com](http://www.mornsun-power.com)

Horizontal Package (without heat sink) Dimensions and Recommended Layout

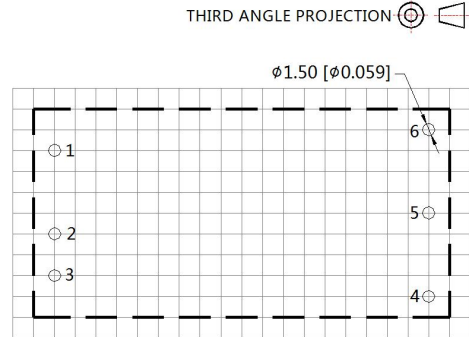
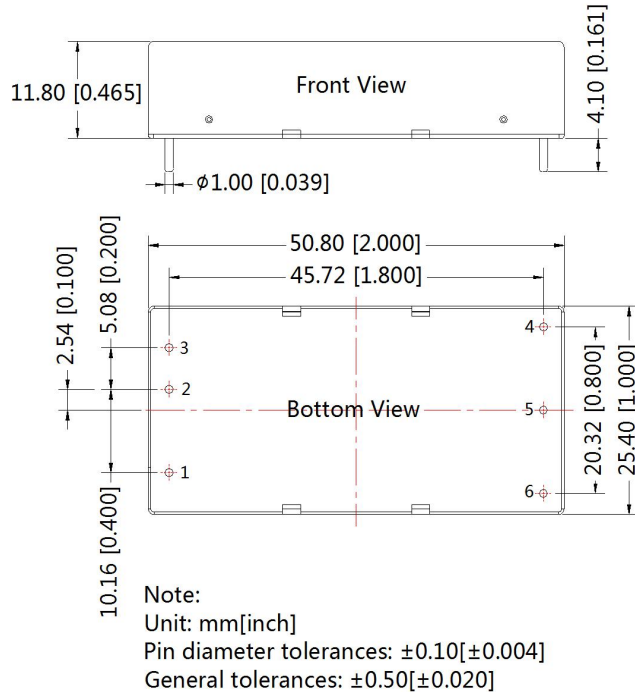

Note : Grid 2.54\*2.54mm

Pin-Out	
Pin	Function
1	Ctrl
2	GND
3	Vin
4	+Vo
5	0V
6	Trim

Horizontal Package (with heat sink) Dimensions

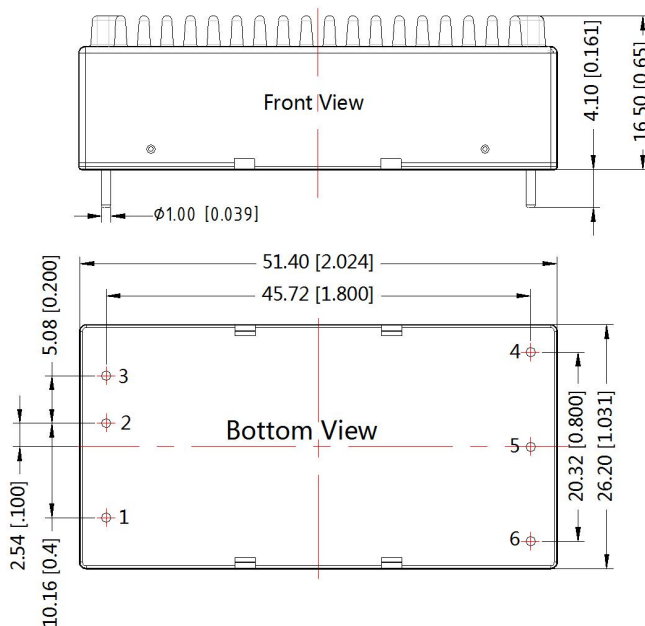

THIRD ANGLE PROJECTION

Pin-Out	
Pin	Function
1	Ctrl
2	GND
3	Vin
4	+Vo
5	0V
6	Trim

Note:  
Unit: mm[inch]  
General tolerances:  $\pm 0.50[\pm 0.020]$

URB1D\_LD-20WR3A2S (without heatsink) Dimensions

THIRD ANGLE PROJECTION

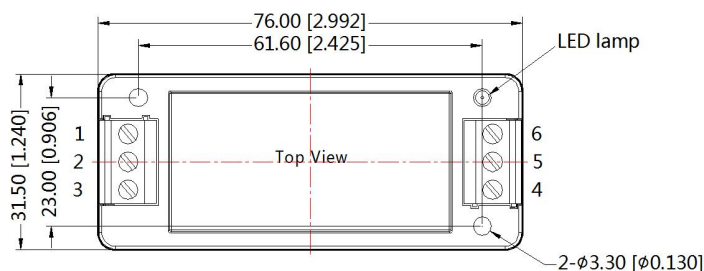

Pin-Out						
Pin	1	2	3	4	5	6
Function	Ctrl	GND	Vin	+Vo	0V	Trim

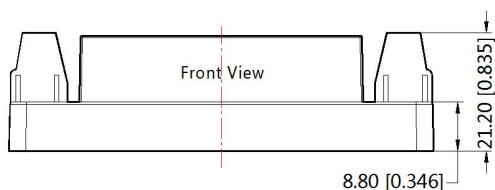

Note:  
Unit: mm[inch]  
Wire range: 24-12 AWG  
Tightening torque: Max 0.4 N·m  
General tolerances: ±0.50[±0.020]

URB1D\_LD-20WHR3A2S (with heatsink) Dimensions

THIRD ANGLE PROJECTION

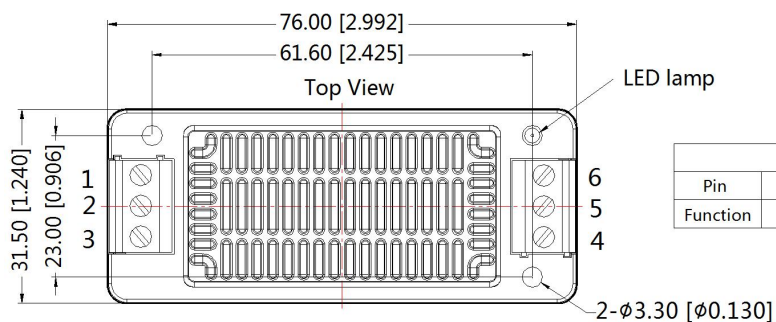

Pin-Out						
Pin	1	2	3	4	5	6
Function	Ctrl	GND	Vin	+Vo	0V	Trim

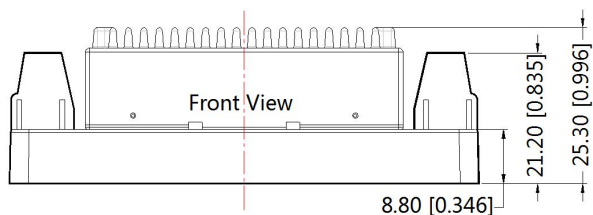

Note:  
Unit: mm[inch]  
Wire range: 24-12 AWG  
Tightening torque: Max 0.4 N·m  
General tolerances: ±1.00[±0.039]

URB1D\_LD-20WR3A4S (without heatsink) Dimensions

THIRD ANGLE PROJECTION 

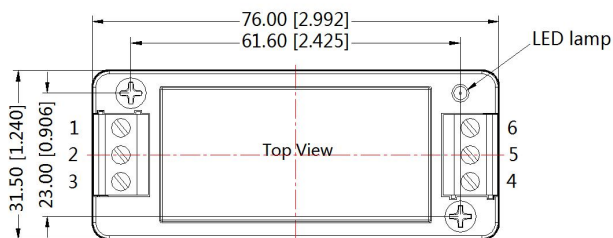

Pin-Out						
Pin	1	2	3	4	5	6
Function	Ctrl	GND	Vin	+Vo	0V	Trim

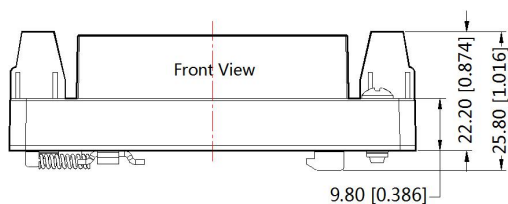

Note:  
Unit: mm[inch]  
Mounting rail: TS35  
Wire range: 24-12 AWG  
Tightening torque: Max 0.4 N·m  
General tolerances:  $\pm 1.00[\pm 0.039]$

URB1D\_LD-20WHR3A4S (with heatsink) Dimensions

THIRD ANGLE PROJECTION 

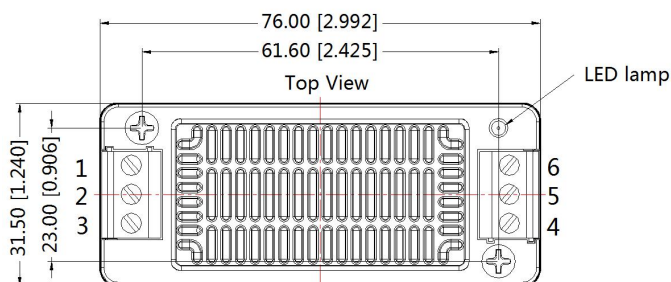

Pin-Out						
Pin	1	2	3	4	5	6
Function	Ctrl	GND	Vin	+Vo	0V	Trim

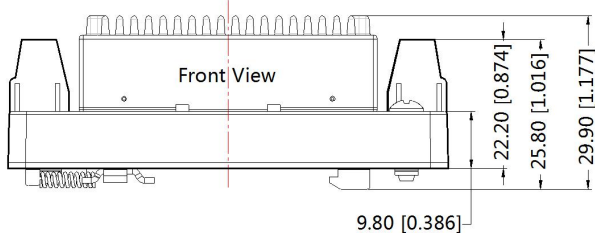

Note:  
Unit: mm[inch]  
Mounting rail: TS35  
Wire range: 24-12 AWG  
Tightening torque: Max 0.4 N·m  
General tolerances:  $\pm 1.00[\pm 0.039]$



Note:

1. For additional information on Product Packaging please refer to [www.mornsun-power.com](http://www.mornsun-power.com). The Packaging bag number of Horizontal packaging: 58200035(without heat sink), 58200051(with heat sink), A2S/A4S packaging number: 58220022;
2. The maximum capacitive load offered were tested at input voltage range and full load;
3. Unless otherwise specified, parameters in this datasheet were measured under the conditions of  $T_a=25^{\circ}\text{C}$ , humidity<75%RH with nominal input voltage and rated output load;
4. All index testing methods in this datasheet are based on Company's corporate standards;
5. Other product application information, please see DC-DC (railway power supply) Converter Application Notes for specific operation methods;
6. We can provide product customization service, please contact our technicians directly for specific information;
7. Products are related to laws and regulations: see "Features" and "EMC";
8. Our products shall be classified according to ISO14001 and related environmental laws and regulations, and shall be handled by qualified units.

## Mornsun Guangzhou Science & Technology Co., Ltd.

Address: No. 5, Kehui St. 1, Kehui Development Center, Science Ave., Guangzhou Science City, Luogang District, Guangzhou, P. R. China  
Tel: 86-20-38601850 Fax: 86-20-38601272 E-mail: [sales@mornsun.cn](mailto:sales@mornsun.cn) [www.mornsun-power.com](http://www.mornsun-power.com)