

DC/DC Converter

PV200-29Bxx Series

MORNSUN®

200W isolation DC-DC converter with ultra-wide, ultra-high 300 - 1500VDC input for Renewable Energy



FEATURES

- Ultra-wide 300 - 1500VDC input voltage range
- High I/O isolation test voltage of 4000VAC
- Industrial grade operating temperature -40°C to +70°C
- High efficiency, low ripple & noise
- High reliability, long lifespan
- Input reverse polarity and undervoltage protection, output short circuit, over-current and over-voltage protection
- Operating up to 5000m altitude



PV200-29Bxx series is a regulated DC-DC converter with an ultra-wide and ultra-high DC input of 300-1500VDC. The product features high efficiency, high reliability, high insulation and a high level of safety protection. This type of power supply is widely used in renewable energy industries, such as photo voltaic, power generation, energy storage, inverters and high voltage DC conversions. The converters provide multiple protection features and guarantee stable and safe operating environments even under abnormal working conditions. For extremely harsh EMC environment, we recommend using the application circuit show in Design Reference of this datasheet.

Selection Guide

Certification	Part No.	Output Power	Nominal Output Voltage and Current (Vo/Io)	Efficiency at 850VDC (%) Typ.	Capacitive Load (μF) Max.
CSA/EN	PV200-29B24	200W	24V/8.4A	86	5000
	PV200-29B48		48V/4.2A	87	2000
--	PV200-29B32		32V/6.25A	87	2000

Input Specifications

Item	Operating Conditions	Min.	Typ.	Max.	Unit
Input Voltage Range		300	--	1500	VDC
Input Current	300VDC	--	--	1200	mA
	850VDC	--	--	450	
	1500VDC	--	--	200	
Inrush Current	850VDC	--	150	--	A
	1500VDC	--	250	--	
Input Under-voltage Protection	Lockout activation range	265	--	285	VDC
	Lockout deactivation range	275	--	295	
External Input Fuse		6A/1500VDC, required			
Hot Plug		Unavailable			

Output Specifications

Item	Operating Conditions	Min.	Typ.	Max.	Unit	
Output Voltage Accuracy	0% - 100% load	--	--	±2	%	
Line Regulation	Full load	--	--	±1		
Load Regulation	0% - 100% load	--	--	±1		
Ripple & Noise*	20MHz bandwidth (peak-to-peak value)	--	200	300	mV	
Temperature Coefficient		--	±0.02	--	%/°C	
Short Circuit Protection		Hiccup, continuous, self-recovery				
Over-current Protection		≥ 110 %Io, hiccup, self-recovery				
Over-voltage Protection	24V output	≤ 35VDC	Output voltage clamp or turn off			
	32V output	≤ 45VDC				
	48V output	≤ 60VDC				
Minimum Load		0	--	--	%	
Hold-up Time	Room temperature, full load	850VDC input	5	--	--	ms
		1500VDC input	8	--	--	
Start-up Delay Time **	300-1500VDC	--	3	--	s	

MORNSUN®

MORNSUN Guangzhou Science & Technology Co., Ltd.

2023.07.04-A/7

Page 1 of 5

MORNSUN Guangzhou Science & Technology Co., Ltd. reserves the copyright and right of final interpretation

Note: * The "parallel cable" method is used for ripple and noise test, please refer to PV Converter Application Notes for specific information.
 ** Start-up delay time test conditions: full voltage input range, full output load range (The cooling-time between input power-off and power-on again is greater than 15s.)

General Specifications

Item	Operating Conditions	Min.	Typ.	Max.	Unit	
Isolation	Input - output	Electric Strength Test for 1min., leakage current $\leq 10\text{mA}$	4000	--	--	VAC
	Input - PE	Electric Strength Test for 1min., leakage current $\leq 5\text{mA}$	2000	--	--	
	Output - PE		2000	--	--	
Operating Temperature		-40	--	+70	°C	
Storage Temperature		-40	--	+85		
Storage Humidity		--	--	95	%RH	
Power Derating	-40°C to -25°C	3.33	--	--	% / °C	
	+55°C to +70°C	3.33	--	--		
	1400 - 1500VDC	0.20	--	--	%/VDC	
	2000m - 5000m	13.3	--	--	%/Km	
Switching Frequency		--	65	--	kHz	
Safety Standard	PV200-29B24/48	CSA-C22.2 No.107.1-16 safety approved & EN62109-1 (Report)				
	PV200-29B32	Design refer to CSA-C22.2 No.107.1-16, EN62109-1				
Over-voltage Rating		CLASS I				
Altitude*		--	--	5000	m	
MTBF		MIL-HDBK-217F@25°C $\geq 300,000$ h				

Note: *CSA certified altitude is: 2000m.

Mechanical Specifications

Case Material	Metal
Dimensions	215.00 x 125.00 x 50.00mm
Weight	1550g (Typ.)
Cooling Method	Free air convection

Electromagnetic Compatibility (EMC)

Emissions	CE	CISPR32/EN55032	CLASS A	
	RE	CISPR32/EN55032	CLASS A	
Immunity	ESD	IEC/EN61000-4-2	Contact $\pm 6\text{KV}$ /Air $\pm 8\text{KV}$	Perf. Criteria B
	RS	IEC/EN61000-4-3	10V/m	Perf. Criteria A
	EFT	IEC/EN61000-4-4	$\pm 2\text{KV}$	Perf. Criteria B
	Surge	IEC/EN61000-4-5	line to line $\pm 1\text{KV}$ / line to ground $\pm 2\text{KV}$	Perf. Criteria B
	CS	IEC/EN61000-4-6	10Vr.m.s	Perf. Criteria A

Product Characteristic Curve

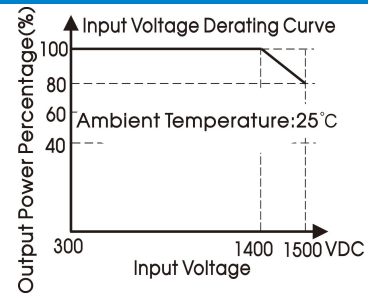
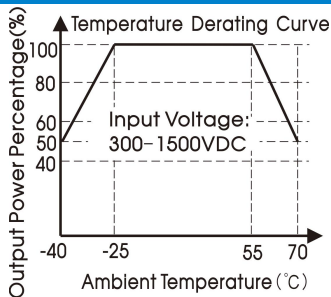

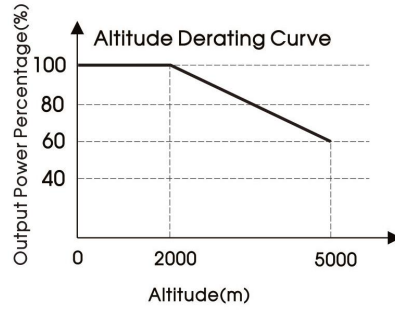

- Note: ① With an input between 1400-1500VDC, the output power must be derated as per temperature derating curves;
 ② For operation of this converter series in an altitude between 2000 - 5000m above sea level, the output power must be derated as per the altitude derating curve;
 ③ This product is suitable for applications using natural air cooling; for applications in closed environment please consult factory or one of our FAE.

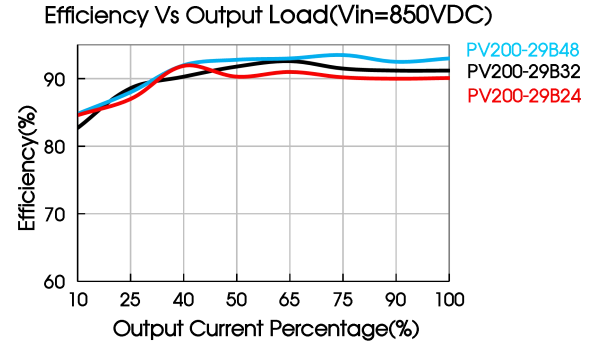
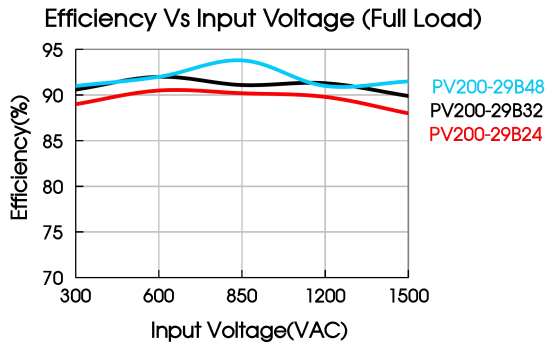

Design Reference

1. Trim Function for Output Voltage Adjustment (open if unused)

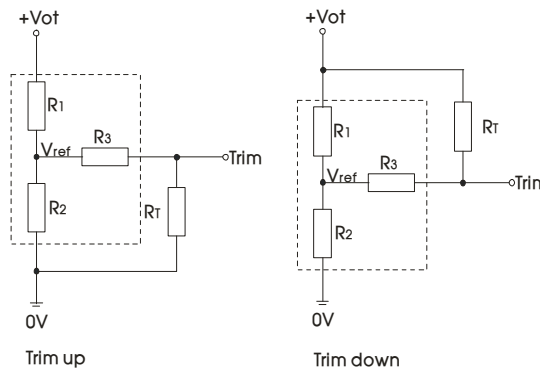

TRIM resistor connection (dashed line shows internal resistor network)

Calculating Trim resistor values:

$$\begin{aligned} \text{up: } R_T &= \frac{\alpha R_2}{R_2 - \alpha} \cdot R_3 & \alpha &= \frac{V_{ref}}{V_{ot} - V_{ref}} \cdot R_1 \\ \text{down: } R_T &= \frac{\alpha R_1}{R_1 - \alpha} \cdot R_3 & \alpha &= \frac{V_{ot} - V_{ref}}{V_{ref}} \cdot R_2 \end{aligned}$$

R_T = Trim Resistor value;
 α = self-defined parameter;
 V_{ot} = desired output voltage

V _{out}	R ₁ (K Ω)	R ₂ (K Ω)	R ₃ (K Ω)	V _{ref} (V)	V _{ot} (V)
24V	8.66	1	1	2.5	Resulting trimmed output voltage, range $\leq \pm 10\%$
32V	11.82	1	1	2.5	
48V	17.8	1	1	2.5	

2. For additional information please refer to application note on www.mornsun-power.com.

Dimensions and Recommended Layout of PV200-29B24/48

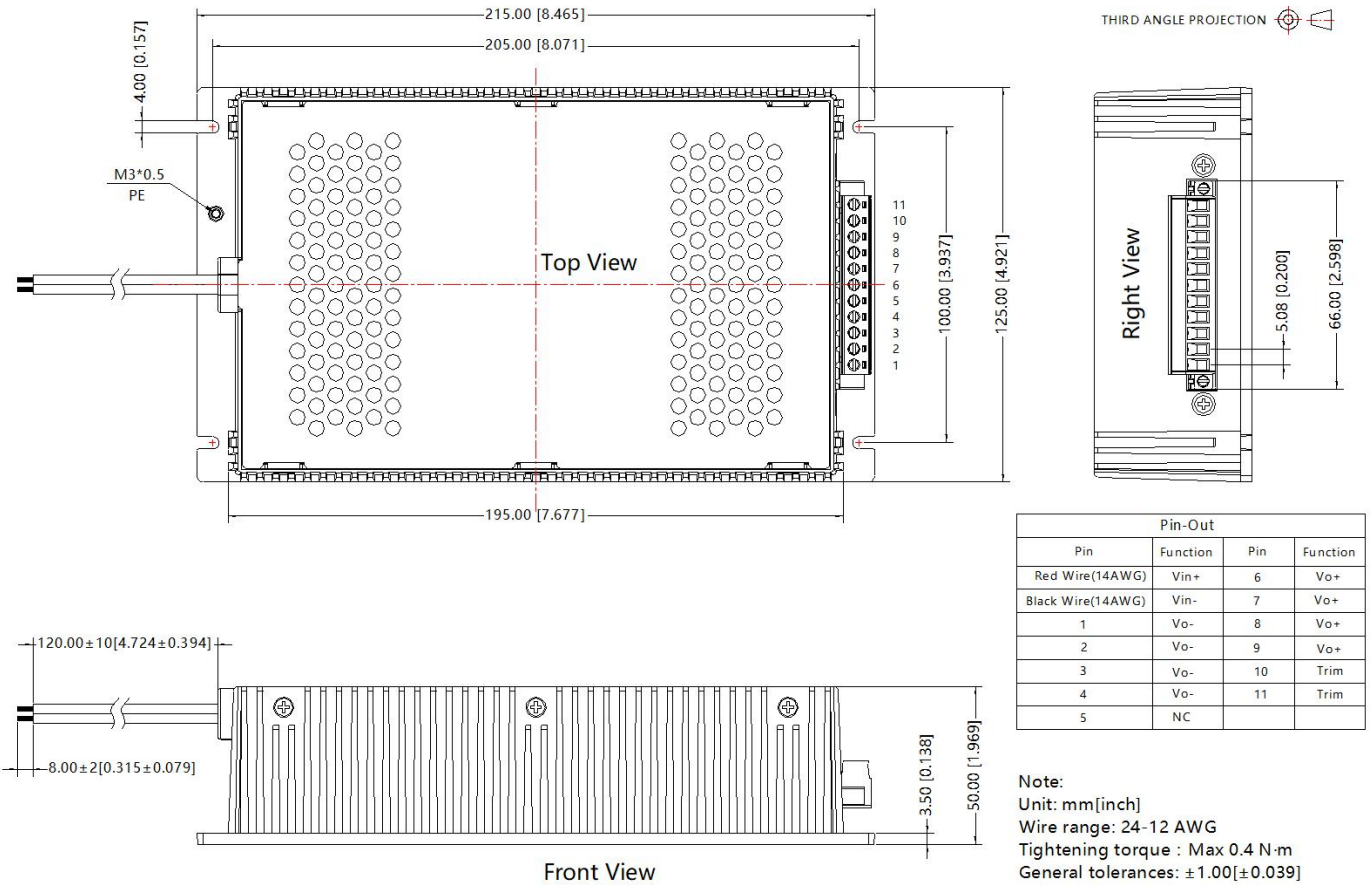

Warning: To reduce the risk of fire, connect only to a circuit provided with branch circuit overcurrent protection in accordance with the National Electrical Code, ANSI/ NFPA 70.

Avertissement: Pour réduire le risque d'incendie, veuillez connecter uniquement à des circuits de dérivation avec protection contre les surintensités conformes au code électrique national ANSI/ NFPA 70.

If may appear that the input wire sleeves are all black when shipped

Dimensions and Recommended Layout of PV200-29B32

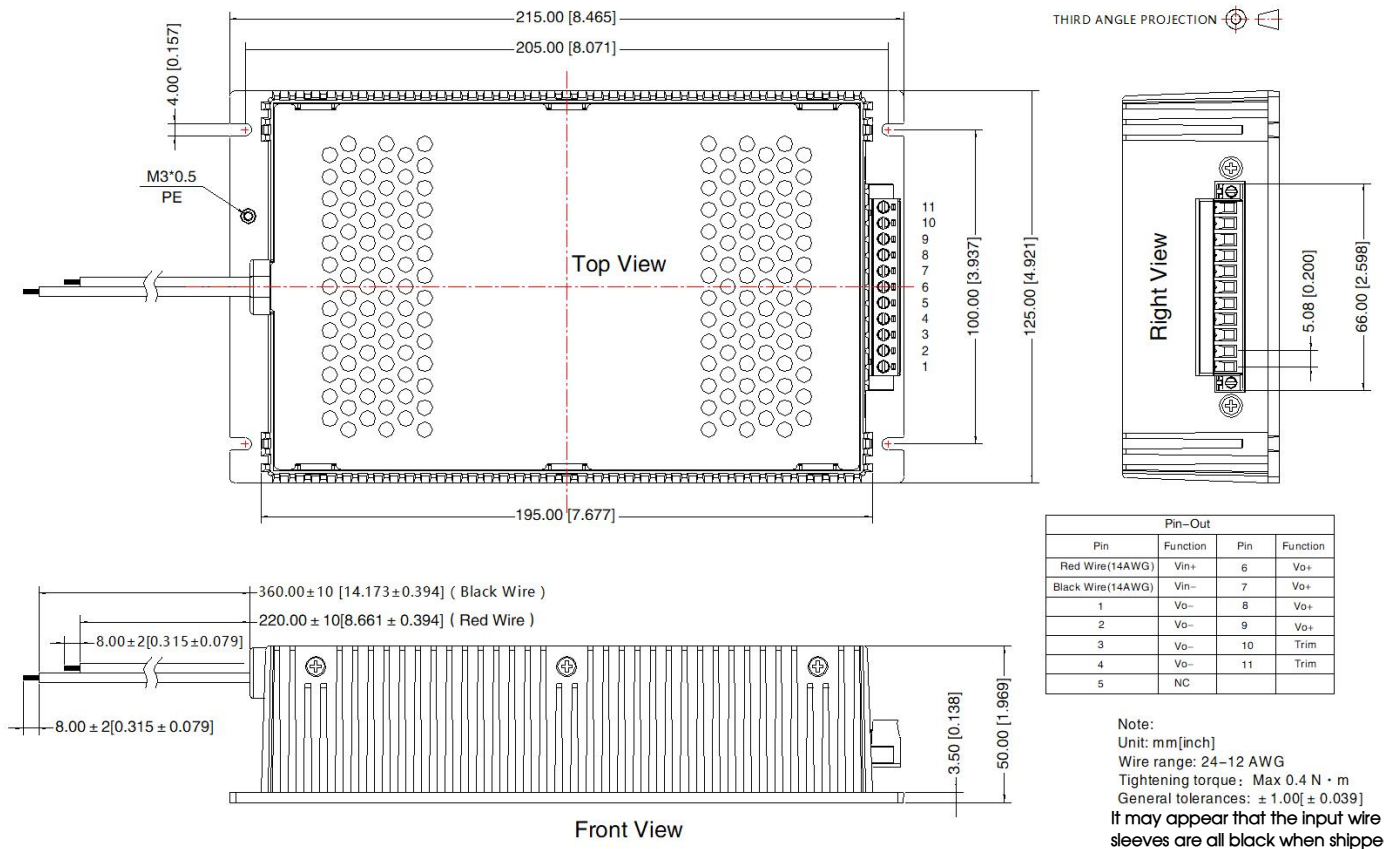

WARNING:

1. WARNING: REPLACE ONLY WITH THE SAME RATINGS AND TYPE OF FUSE.
2. WARNING: SHOCK HAZARD. HORIZONTAL PACKAGE ONLY FOR MOUNTING IN A RACK OR ENCLOSURE FULLY ENCLOSING ALL LIVE PARTS.
3. DANGER — HIGH VOLTAGE.

AVERTISSEMENT:

1. AVERTISSEMENT : N'UTILISER QUE DES FUSIBLES DE MÊME CALIBRE ET DE MÊME TYPE QUE LE FUSIBLE D'ORIGINE.
2. AVERTISSEMENT: PAQUET HORIZONTAL RISQUE D'ÉLECTROCUTION. UNIQUEMENT POUR LE MONTAGE DANS UN RACK OU UN ENCEINTE ENFERMANT ENTIÈREMENT TOUTES LES PIÈCES SOUS TENSION.
3. DANGER : HAUTE TENSION.

Note:

1. For additional information on Product Packaging please refer to www.mornsun-power.com. Packaging bag number: 58220053;
2. Unless otherwise specified, parameters in this datasheet were measured under the conditions of Ta=25°C, humidity<75% with nominal input voltage and rated output load;
3. All index testing methods in this datasheet are based on our company corporate standards;
4. In order to improve the efficiency, there will be audible noise generated when working at input voltage higher than 1000VDC, but it does not affect product performance and reliability;
5. We can provide product customization service, please contact our technicians directly for specific information;
6. Products are related to laws and regulations: see "Features" and "EMC";
7. Our products shall be classified according to ISO14001 and related environmental laws and regulations, and shall be handled by qualified units;
8. The input end shall be externally connected with a lightning protection device (SVR=6000V).

Mornsun Guangzhou Science & Technology Co., Ltd.

Address: No. 5, Kehui St. 1, Kehui Development Center, Science Ave., Guangzhou Science City, Huangpu District, Guangzhou, P. R. China
Tel: 86-20-38601850 Fax: 86-20-38601272 E-mail: info@mornsun.cn www.mornsun-power.com