

4.8W isolated DC/DC converter
Wide input voltage & regulated dual output
Dedicated for IGBT Driver

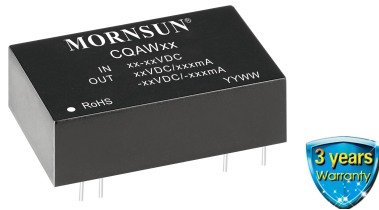

Patent Protection **RoHS**

FEATURES

- Wide input voltage range
- High efficiency up to 83%
- I/O isolation test voltage: 3k VDC
- Operating ambient temperature range: -40°C to +105°C
- Industry standard pin-out
- Components meet AEC-Q101 standards

CQAW01 product features output power of 4.8W, wide input voltage range of 7VDC to 18VDC, input and output isolation voltage up to 3000VDC, and the working temperature range from -40°C to +105°C. The production process is controlled according to the requirements of the TS16949 system and the components comply with the AEC-Q101 standard. It is widely used in automotive systems and related equipment.

Selection Guide

Part No.	Input Voltage(VDC)		Output		Full Load Efficiency(%) Min./Typ.	Capacitive Load ^② (μF) Max.
	Nominal (Range)	Max. ^①	Voltage (VDC)	Current (mA) Max./Min.		
CQAW01	12 (7-18)	20	+15/-9	±200/±10	81/83	680

Note:

- ① Exceeding the maximum input voltage may cause permanent damage;
② For dual output converter, the given value is the same for each output.

Input Specifications

Item	Operating Conditions	Min.	Typ.	Max.	Unit
Input Current (full load/ no-load)	12VDC input	--	482/35	494/50	mA
Reflected Ripple Current	12VDC input	--	30	--	
Surge Voltage (60sec. max.)		-0.7	--	30	VDC
Start-up Voltage		--	6.5	7	
No-load Power		--	0.36	--	W
Input Filter		Pi filter			
Hot Plug		Unavailable			

Output Specifications

Item	Operating Conditions	Min.	Typ.	Max.	Unit
Power		0.24	--	4.8	W
Voltage Accuracy	5%-100% load (+15V output)	--	±5	±10	%
	5%-100% load (-9V output)	--	±5	±10	
Linear Regulation	Input voltage variation from low to high at full load	--	±5	±10	
Load Regulation	5%-100% load	--	±5	±10	
Temperature Coefficient	Full load	--	--	±0.03	%/°C
Ripple & Noise*	20MHz bandwidth , 5%-100% load	--	100	200	mV
Short-circuit Protection		None			

Note: * The "parallel cable" method is used for Ripple and Noise test, please refer to DC-DC Converter Application Notes for specific information.

General Specifications

Item	Operating Conditions	Min.	Typ.	Max.	Unit
Isolation	Input-output Electric strength test for 1 minute with a leakage current of 1mA max.	3000	--	--	VDC
Insulation Resistance	Input-output resistance at 500VDC	1000	--	--	MΩ
Isolation Capacitance	Input-output capacitance at 100kHz/0.1V	--	50	--	pF
Operating Temperature	See Fig. 1	-40	--	+105	°C

Storage Temperature		-55	--	+125	°C
Storage Humidity	Non-condensing	--	--	95	%RH
Pin Soldering Resistance Temperature	Soldering spot is 1.5mm away from case for 10 seconds	--	--	+300	°C
Vibration		10-55Hz, 10G, 30 Min. along X, Y and Z			
Switching Frequency	Full load, nominal input	--	380	--	kHz
MTBF	MIL-HDBK217F@25°C	1000	--	--	k hours

Mechanical Specifications

Case Material	Black plastic; flame-retardant and heat-resistant (UL94 V-0)
Dimensions	31.60 x 20.30 x 10.20 mm
Weight	14.0g (Typ.)
Cooling Method	Forced convection (the wind speed: 0.8m/s)

Electromagnetic Compatibility (EMC)

Emissions	CE	EN55025 / CISPR25	CLASS 3 (see Fig.3-② and Fig.3-③ for recommended circuit)
	RE	EN55025 / CISPR25	CLASS 3 (see Fig.3-② and Fig.3-③ for recommended circuit)
Immunity	ESD	IEC/EN61000-4-2	Contact ±4kV perf. Criteria B
	RS	IEC/EN61000-4-3	10V/m perf. Criteria A
	EFT	IEC/EN61000-4-4	±2kV (see Fig.3-① for recommended circuit) perf. Criteria B
	Surge	IEC/EN61000-4-5	line to line ±2kV (see Fig.3-① for recommended circuit) perf. Criteria B
	CS	IEC/EN61000-4-6	3 Vr.m.s perf. Criteria A
	Immunities of voltage dip, drop and short interruption	IEC/EN61000-4-29	0%, 70%

Typical Characteristic Curves

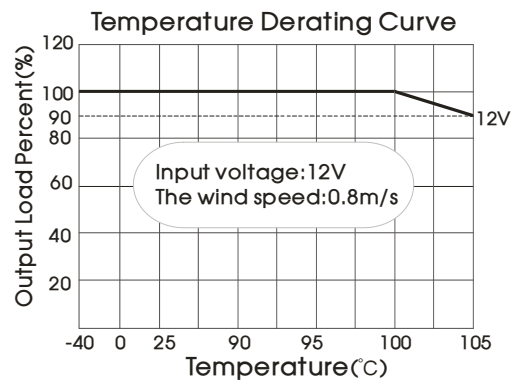
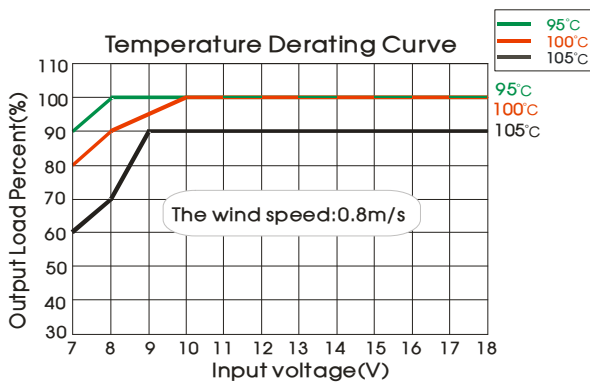
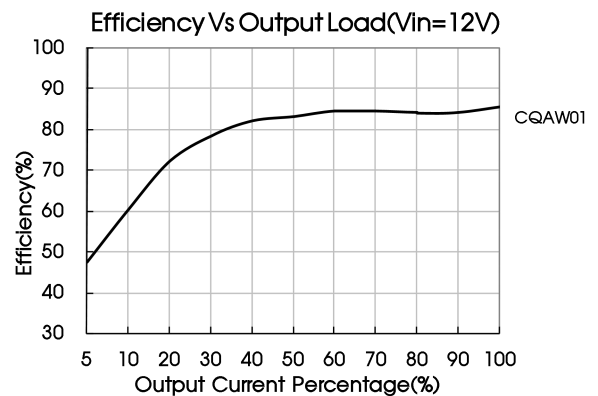
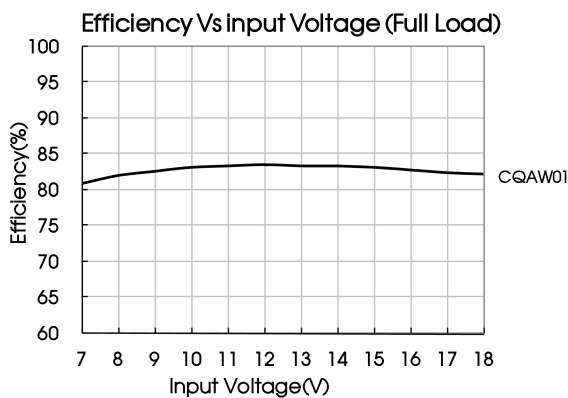

Fig. 1



Design Reference

1. Typical application

All the IGBT driver of this series are tested before delivery using the recommended circuit shown in Fig. 2.

Input and/or output ripple can be further reduced by appropriately increasing the input & output capacitor values C_{in} and C_{out} and/or by selecting capacitors with a low ESR (equivalent series resistance). Also make sure that the capacitance is not exceeding the specified max. capacitive load value of the product.



Fig. 2

V_{in}	12V
C_{in}	100 μ F
C_{out}	100 μ F

2. EMC solution-recommended circuit

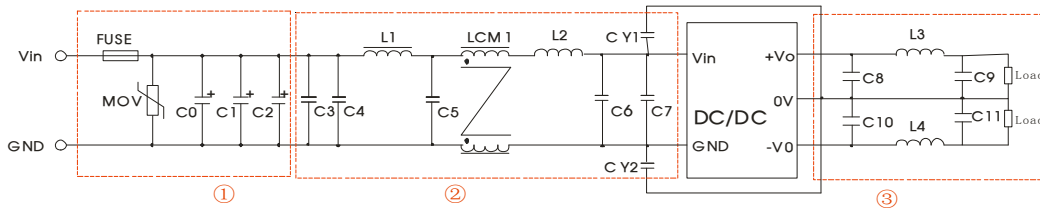
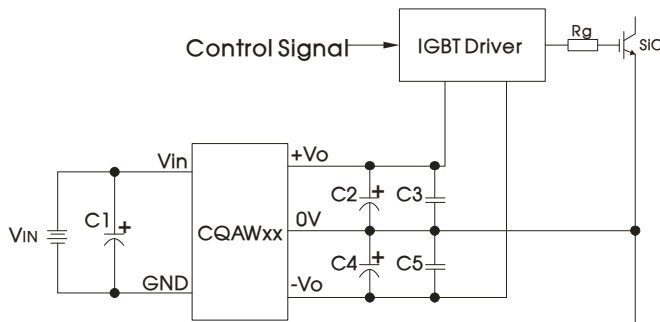

Fig. 3

Notes: For EMC tests we use Part ① in Fig. 3 for immunity and part ② for emissions test. Selecting based on needs.

Model	CQAW01
FUSE	Choose according to actual input current
MOV	S14k20
C0, C1, C2	330 μ F/50V
C3	4.7 μ F/50V
C4	10 μ F/50V
L1	4.7 μ H
C5	0.1 μ F/50V
LCM1	10mH
L2, L3, L4	1700 Ω /60MHz
C6, C8, C9, C10, C11	0.1nF/50V
C7	1nF/50V
CY1, CY2	561k/400VAC

3. Application circuit



C1: 100 μ F/63V (Electrolytic capacitor)
C2,C4: 100 μ F/35V (Electrolytic capacitor)
C3,C5: 10 μ F/25V (Ceramic capacitor)

Application Notes

1. The wire between the converter and IGBT driver must as short as possible.
2. External filter capacitors should be connected as close as possible to the IGBT driver.
3. To ensure the high peak gate current, the filter capacitors should be electrolytic capacitor and ceramic capacitor collocation.
4. The output average power of the IGBT driver should be less than the output power of DC-DC module.

4. The products do not support parallel connection of their output

5. For additional information please refer to DC-DC converter application notes on

www.mornsun-power.com.

Dimensions and Recommended Layout

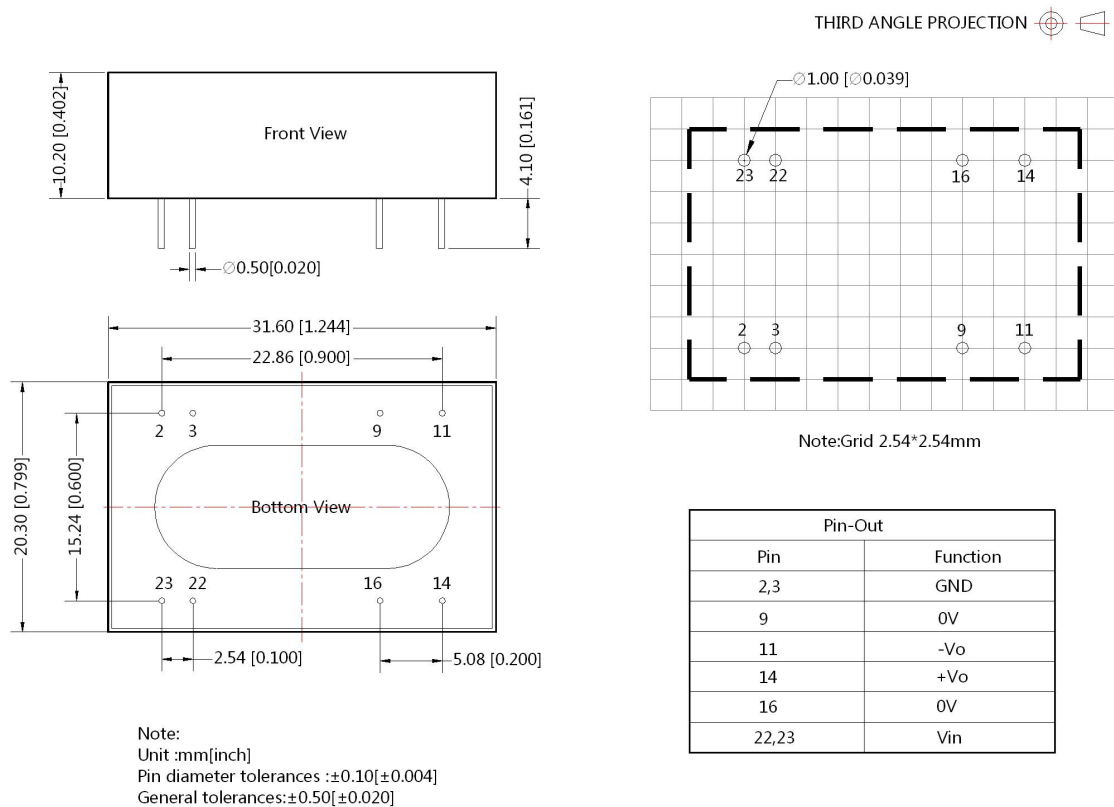

- Note:
- For additional information on Product Packaging please refer to www.mornsun-power.com. Packaging bag number: 58210008;
 - Recommend to use module with more than 5% load, if not, the ripple of the product may exceeds the specification, but does not affect the reliability of the product;
 - The recommended unbalance degree of the dual output module load is $\leq \pm 5\%$; if the degree exceeds $\pm 5\%$, than the product performance cannot be guaranteed to comply with all parameters in the datasheet. Please contact our technicians directly for specific information;
 - The maximum capacitive load offered were tested at input voltage range and full load;
 - Unless otherwise specified, parameters in this datasheet were measured under the conditions of $T_a=25^\circ\text{C}$, humidity<75%RH with nominal input voltage and rated output load;
 - All index testing methods in this datasheet are based on company corporate standards;
 - We can provide product customization service, please contact our technicians directly for specific information;
 - Products are related to laws and regulations see "Features" and "EMC";
 - Our products shall be classified according to ISO14001 and related environmental laws and regulations, and shall be handled by qualified units.

Mornsun Guangzhou Science & Technology Co., Ltd.

Address: No. 5, kehui St. 1, kehui Development Center, Science Ave., Guangzhou Science City, Luogang District, Guangzhou, P. R. China
Tel: 86-20-38601850 Fax: 86-20-38601272 E-mail: info@mornsun.cn www.mornsun-power.com