



FEATURES

- Universal 85 - 264VAC or 120 - 370VDC input voltage
- High power density, compact size: 3" x 2" x 1.22"
- Operating ambient temperature range: -40°C to +85°C
- Active PFC
- High I/O isolation test voltage up to 4000VAC
- Operating altitude up to 5000m
- Extremely low leakage current <0.1mA
- Stand-by power consumption 0.5W Typ.
- The base plate with conformal coating
- Output short circuit, over-current, over-voltage, Over-temperature protection
- Efficiency up to 95%
- Suitable for BF application
- 5 years warranty
- Installing in system of Safety Class I/II is available



LOF120-20Bxx series is one of Mornsun's AC-DC miniaturize open frame power supply and suitable for all kinds of BF type (be accessible to patients) medical system equipment. It features universal AC input and at the same time accepts DC input voltage, cost-effective, high efficiency, high reliability and double or reinforced insulation. These converters offer excellent EMC and safety performance, which meet IEC/EN/UL62368, GB4943, IEC/EN60335, IEC/EN61558, IEC/EN/ES60601, IEC60950 standards and they are widely used in areas of industrial, LED, street light control, electricity, security, telecommunications, smart home, medical, etc.

Selection Guide

Certification	Part No.*	Nominal Output Power (W)	Nominal Output Voltage and Current (Vo/Io)	Transient Output Power*10S (W)	Output Voltage Adjustable Range (V)	Efficiency at 230VAC (%) Typ.	Max. Capacitive Load (µF)
UL/EN/BS/BIS	LOF120-20B12	114	12V/9.5A	141.6	11.4-12.6	94	6000
	LOF120-20B15	114	15V/7.6A	142.5	14.3-15.8	94	5000
EN/BS/BIS	LOF120-20B19	119.7	19V/6.3A	149	17.3-19.8	93	4500
UL/EN/IEC/BS/BIS	LOF120-20B24	120	24V/5A	150	22.8-25.2	95	3200
	LOF120-20B27	119.9	27V/4.44A	149.8	25.6-28.4	95	2400
UL/EN/BS/BIS	LOF120-20B36	120	36V/3.33A	149.76	35.28-37.8	94	2000
UL/EN/IEC/BS/BIS	LOF120-20B48	120	48V/2.5A	150	45.6-50.4	94.5	1600
EN/BS	LOF120-20B54	120	54V/2.22A	149.58	51.3-55.5	94	1300

Note: 1.*If the total output power exceeds the nominal output power, it can be maintained for a maximum of 10s. The power supply cannot exceed the transient power. When the output voltage is increased, the total output power cannot exceed the nominal output power;

2.*The maximum transient output power interval must be greater than 30 minutes;

3.*Except 19V, other LOF products with shell is also available, named LOF120-20Bxx-C.

Input Specifications

Item	Operating Conditions		Min.	Typ.	Max.	Unit
Input Voltage Range	AC input		85	--	264	VAC
	DC input		120	--	370	VDC
Input Voltage Frequency			47	--	63	Hz
Input Current	115VAC		--	--	2	A
	230VAC		--	--	1	
Inrush Current	115VAC	Cold start	--	40	--	A
	230VAC		--	75	--	
Power Factor	115VAC	Full load	0.98	--	--	--
	230VAC		0.94	--	--	

Leakage Current	240VAC	<0.1mA; Single fault <0.5mA
Hot Plug		Unavailable

Output Specifications

Item	Operating Conditions	Min.	Typ.	Max.	Unit	
Output Voltage Accuracy*	Full load range	12V/15V	--	±2.0	--	%
		19V/24V/27V/36V/48V/54V	--	±1.0	--	
Line Regulation	Rated load	--	±0.5	--	%	
Load Regulation	0% - 100% load	--	±1.0	--		
Ripple & Noise*	20MHz bandwidth (peak-to-peak value)	12V/15V	--	--	120	mV
		19V/24V/27V	--	--	150	
		36V/48V/54V	--	--	200	
Temperature Coefficient		--	±0.03	--	%/°C	
Minimum Load		0	--	--	%	
Hold-up Time	230VAC, 25°C	15	--	--	ms	
Stand-by Power Consumption		--	0.5	--	W	
Short Circuit Protection	Recovery time < 3s after the short circuit disappear	Hiccup, continuous, self-recover				
Over-current Protection		≥130% Io, hiccup, self-recover				
Over-voltage Protection	12V	≤16V (Output voltage turn off, re-power on for recover)				
	15V	≤25V (Output voltage turn off, re-power on for recover)				
	19V	≤25V (Output voltage turn off, re-power on for recover)				
	24V	≤32V (Output voltage turn off, re-power on for recover)				
	27V	≤35V (Output voltage turn off, re-power on for recover)				
	36V	≤50V (Output voltage turn off, re-power on for recover)				
	48V	≤60V (Output voltage turn off, re-power on for recover)				
	54V	≤60V (Output voltage turn off, re-power on for recover)				
Over-temperature Protection		Output voltage turn off, re-power on to recover after abnormal removed				

- Note: 1. *Output voltage accuracy: including the setting error, line regulation, load regulation;
 2. *The "Tip and barrel method" is used for ripple and noise test, output parallel 10uF electrolytic capacitor and 0.1uF ceramic capacitor, please refer to AC-DC Converter Application Notes for specific information;
 3. *For all the above test items, please refer to our company standard "AC-DC Black Box Test Specification" for specific test specifications and methods;
 4. *When the product works at light load (≤15% IO), in order to improve the efficiency to reach at green working mode, the value of ripple and noise will be double.

General Specifications

Item	Operating Conditions	Min.	Typ.	Max.	Unit
Isolation Test	Input - ⊕	1500	--	--	VAC
	Input - output	4000	--	--	
	Output - ⊕	1500	--	--	
Insulation Resistance	Input - ⊕	100	--	--	MΩ
	Input - output	100	--	--	
	Output - ⊕	100	--	--	
Isolation level	Input - output	2 x MOPP			
	Input - ⊕	1 x MOPP			
	Output - ⊕	1 x MOPP			

Operating Temperature		-40	--	+85	°C
Storage Temperature		-40	--	+85	
Storage Humidity	Non-condensing	10	--	95	%RH
Operating Humidity		20	--	90	
Power Derating	Operating temperature derating	+50°C to +85°C	Air cooling		% / °C
		+55°C to +85°C	10CFM		
		-40°C to -30°C			
	Input voltage derating	85VAC-115VAC	Air cooling		
	85VAC-100VAC	10CFM			
Safety Standard	12V/15V/24V/27V/48V	IEC/UL62368-1, ES60601-1, IS13252 (Part1) safety approved & EN62368-1, EN60335-1, EN61558-1, EN60601-1, BS EN62368-1 (Report) Design refer to IEC/EN/UL62368-1, EN60335-1, IEC/EN61558-1, GB4943.1, IEC/EN60601-1, ES60601-1(3.1 version), CAN/CSA-C22.2 No.60601-1:14-Edition 3, EN60601-1-2 Edition 4 IEC60950-1			
	36V	ES60601, IS13252 (Part1) safety approved & EN60601-1, BS EN62368-1 (Report) Design refer to IEC/EN/UL62368-1, EN60335-1, IEC/EN61558-1, GB4943.1, IEC/EN60601-1, ES60601-1(3.1 version), CAN/CSA-C22.2 No.60601-1:14-Edition 3, EN60601-1-2 Edition 4 IEC60950-1			
	19V	IS13252 (Part1) safety approved & EN62368-1, BS EN62368-1 (Report) Design refer to IEC/EN/UL62368-1, EN60335-1, IEC/EN61558-1, GB4943.1, IEC/EN60601-1, ES60601-1(3.1 version), CAN/CSA-C22.2 No.60601-1:14-Edition 3, EN60601-1-2 Edition 4 IEC60950-1			
	54V	EN62368-1, BS EN62368-1 (Report) Design refer to IEC/EN/UL62368-1, EN60335-1, IEC/EN61558-1, GB4943.1, IEC/EN60601-1, ES60601-1(3.1 version), CAN/CSA-C22.2 No.60601-1:14-Edition 3, EN60601-1-2 Edition 4 IEC60950-1			
Safety Class		CLASS I (with PE and must be connected)/ CLASS II (without PE)			
MTBF	MIL-HDBK-217F@25°C	>300,000 h			
Warranty	Ambient temperature: <50°C	5 years			

Mechanical Specifications

Case Material	Open frame
Dimensions	76.20mm x 50.80mm x 31.00mm
Weight	125g (Typ.)
Cooling Method*	Air cooling / 10CFM
Note: *Cooling method and power derating refer to typical characteristic curves.	

Electromagnetic Compatibility (EMC)

Emissions*	CE	CISPR32/EN55032 CLASS B		
	RE	CISPR32/EN55032 (Category I, CLASS B, category II, CLASS A)		
	Harmonic current	IEC/EN61000-3-2 CLASS A and CLASS D		
	Voltage flicker	IEC/EN61000-3-3		
Immunity	ESD	IEC/EN 61000-4-2	Contact ±8KV/Air ±15KV	perf. Criteria A
	RS	IEC/EN 61000-4-3	10V/m	perf. Criteria A
	EFT	IEC/EN 61000-4-4	±2KV	perf. Criteria A
	Surge	IEC/EN 61000-4-5	line to line ±2KV/line to ground ±4KV	perf. Criteria A

CS	IEC/EN61000-4-6 10 Vr.m.s	perf. Criteria A
Voltage dips, short interruptions and voltage variations immunity	IEC/EN61000-4-11 0%, 70%	perf. Criteria B

Note: 1.*The power supply should be considered as a part of the components in the system. All EMC performance are been tested on a metal plate with a thickness of 1mm and a length of 360mm x 360mm. The power supply must be combined with the terminal equipment for electromagnetic compatibility confirmation;

2.*Category I products with PE (which must be connected), category II products without PE.

Product Characteristic Curve

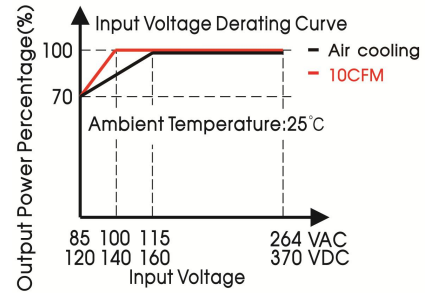
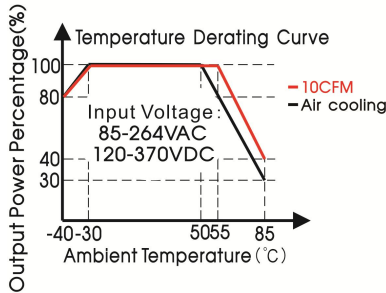

Note: With an AC input voltage between 85 - 115VAC and a DC input between 120 - 160VDC the output power must be derated as per the temperature derating curves.

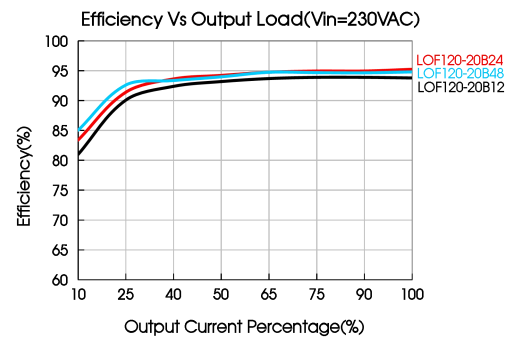
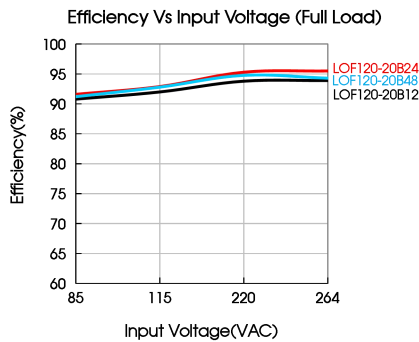

Dimensions and Recommended Layout

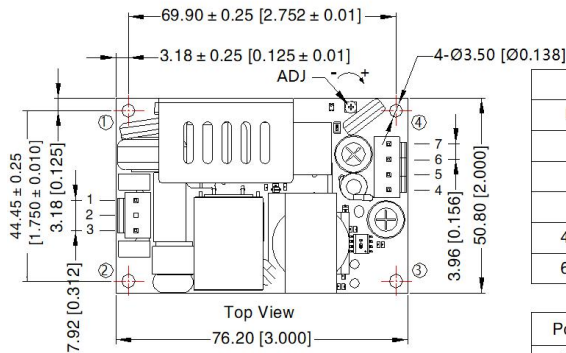

THIRD ANGLE PROJECTION

Pin-Out			
Pin	Mark	Product Connector	Customer Connector
1	AC(N)	JST B3P-VH or equivalent	Housing: JST VHR Contact: JST SVH-21T-P1.1 or PJA-016(Mornsun Product No.)
2	NC		
3	AC(L)		
4, 5	-Vo	JST B4P-VH or equivalent	Housing: JST VHR Contact: JST SVH-21T-P1.1 or PJA-017(Mornsun Product No.)
6, 7	+Vo		

Position	Screw Spec.	L(Recommend)	Torque(max)
① - ④	M3	6mm	0.4N · m

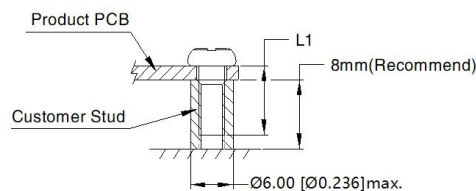
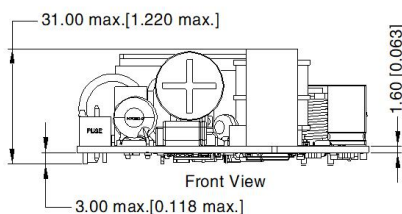

Note:

- Unit: mm[inch]
- General tolerances: $\pm 1.00[\pm 0.039]$
- The layout of the device is for reference only, please refer to the actual product
- Class I system ①, ④ positions must be connected to the earth(\oplus)
- Class II system ①, ④ positions must be connected together

Note:

1. For additional information on Product Packaging please refer to www.mornsun-power.com. Packaging bag number: 58220141;
2. Unless otherwise specified, parameters in this datasheet were measured under the conditions of $T_a=25^{\circ}\text{C}$, humidity<75%RH with nominal input voltage and rated output load;
3. All index testing methods in this datasheet are based on our company corporate standards;
4. In order to improve the efficiency at high input voltage, there will be audible noise generated, but it does not affect product performance and reliability;
5. We can provide product customization service, please contact our technicians directly for specific information;
6. Products are related to laws and regulations: see "Features" and "EMC";
7. Our products shall be classified according to ISO14001 and related environmental laws and regulations, and shall be handled by qualified units;
8. CAUTION: Double pole, neutral fusing. Disconnect mains before servicing. / "ATTENTION: Double pôle/fusible sur le neutre. Débrancher l'alimentation avant l'entretien;
9. The power supply is considered a component which will be installed into a terminal equipment. All EMC tests should be confirmed with the final equipment. Please consult our FAE for EMC test operation instructions;
10. The surface of product should keep a safe distance from the customer system (recommended $\geq 3\text{mm}$), if not, please consult Mornsun FAE.

Mornsun Guangzhou Science & Technology Co., Ltd.

Address: No. 5, Kehui St. 1, Kehui Development Center, Science Ave., Guangzhou Science City, Huangpu District, Guangzhou, P. R. China
Tel: 86-20-38601850 Fax: 86-20-38601272 E-mail: info@mornsun.cn www.mornsun-power.com