

# DC/DC Converter

## URF\_LP-20WR3 Series

20W isolated DC-DC converter in DIP package  
Ultra-wide input and regulated single output



Patent Protection RoHS



UL60950-1

EN62368-1

BS EN62368-1

IEC60950-1

URF\_LP-20WR3 series are isolated 20W DC-DC converter products with a 4:1 input voltage range. They feature efficiencies of up to 89%, 3000VDC input to output isolation, operating ambient temperature of -40°C to +85°C, input under-voltage protection, output short-circuit, over-voltage and over-current protection. The products meet CLASS A of CISPR32/EN55032 EMI standards, optional packages are offered for chassis or DIN-rail mounting (A2S, A4S), adding additional input reverse polarity protection. They are widely used in applications of requiring ultra-wide input voltage and high isolation, such as electrical power industry, data transmission, battery powered devices, telecommunication, distributed power systems, hybrid module system, remote control systems, industrial robotics, etc.

## FEATURES

- Ultra-wide 4:1 input voltage range
- High efficiency up to 89%
- No-load power consumption as low as 0.12W
- I/O isolation test voltage 3k VDC
- Operating ambient temperature range: -40°C to +85°C
- Input under-voltage protection, output short-circuit, over-voltage, over-current protection
- CISPR32/EN55032 CLASS A EMI compliant without external components
- Industry standard pin-out
- Input reverse polarity protection available with chassis (A2S) or 35mm DIN-Rail mounting (A4S) version

## Selection Guide

Certification	Part No. ①	Input Voltage (VDC)		Output		Full Load Efficiency ③ (%) Min./Typ.	Capacitive Load (μF)Max.
		Nominal (Range)	Max. ②	Voltage (VDC)	Current (mA) (Max./Min.)		
UL/EN/BS EN/IEC	URF2403LP-20WR3	24 (9-36)	40	3.3	5000/0	84/86	10000
	URF2405LP-20WR3			5	4000/0	87/89	10000
	URF2409LP-20WR3			9	2222/0	86/88	4700
	URF2412LP-20WR3			12	1667/0	86/88	1600
	URF2415LP-20WR3			15	1334/0	87/89	1000
--	URF2418LP-20WR3			18	1111/0	87/89	680
	URF2424LP-20WR3			24	833/0	87/89	500
UL/EN/BS EN/IEC	URF4803LP-20WR3	48 (18-75)	80	3.3	5000/0	83/85	10000
	URF4805LP-20WR3			5	4000/0	86/88	10000
	URF4812LP-20WR3			12	1667/0	86/88	1600
	URF4815LP-20WR3			15	1334/0	87/89	1000
	URF4824LP-20WR3			24	833/0	87/89	500

Notes:

① Use "A2S" suffix for chassis mounting and "A4S" suffix for DIN-Rail mounting;

② Exceeding the maximum input voltage may cause permanent damage;

③ Efficiency is measured at nominal input voltage and rated output load; efficiencies for A2S and A4S Model's is decreased by 2% due to the input reverse polarity protection circuit.

## Input Specifications

Item	Operating Conditions	Min.	Typ.	Max.	Unit
Input Current (full load/no-load)	24VDC input	3.3V output	--	799/40	819/45
		5V output	--	936/40	958/45
		Other output	--	947/10	969/20

Input Current (full load/no-load)	48VDC input	3.3V output	--	400/20	410/25	mA
		5V output	--	473/20	485/25	
		Other output	--	473/5	485/8	
Reflected Ripple Current	24VDC input	--	30	--		
	48VDC input	--	30	--		
Surge Voltage (1sec. max.)	24VDC input	-0.7	--	50		VDC
	48VDC input	-0.7	--	100		
Start-up Voltage	24VDC input	--	--	9		
	48VDC input	--	--	18		
Input Under-voltage Protection	24VDC input	5.5	6.5	--		
	48VDC input	12.0	15.5	--		
Start-up Time	Nominal input& constant resistance load		--	10	--	ms
Input Filter	Pi filter					
Hot Plug	Unavailable					
Ctrl*	Module on		Ctrl pin open or pulled high (3.5-12VDC)			
	Module off		Ctrl pin pulled low to GND (0-1.2VDC)			
	Input current when off		--	4	7	mA

Note: \*The Ctrl pin voltage is referenced to input GND.

## Output Specifications

Item	Operating Conditions	Min.	Typ.	Max.	Unit	
Voltage Accuracy	0%-100% load	--	±1	±3		
Linear Regulation	Input voltage variation from low to high at full load	--	±0.2	±0.5	%	
Load Regulation	0%-100% load	--	±0.5	±1		
Transient Recovery Time	25% load step change, nominal input voltage	--	300	500	µs	
Transient Response Deviation		3.3V, 5V output	--	±5	±8	%
		Others	--	±3	±5	
Temperature Coefficient	Full load	--	--	±0.03	%/°C	
Ripple & Noise*	20MHz bandwidth, 5%-100% load	--	50	100	mV p-p	
Over-voltage Protection	Input voltage range	110	--	160	%Vo	
Trim		90	--	110		
Over-current Protection		110	--	190		%Io
Short-circuit Protection		Hiccup, continuous, self-recovery				
Note: *Under 0% -5% load conditions, ripple & noise does not exceed 5%Vo. The "parallel cable" method is used for ripple and noise test, please refer to DC-DC Converter Application Notes for specific information.						

## General Specifications

Item	Operating Conditions	Min.	Typ.	Max.	Unit
Isolation	Input-output Electric Strength test for 1 minute with a leakage current of 1mA max.	3000	--	--	VDC
Insulation Resistance	Input-output insulation at 500VDC	1000	--	--	MΩ
Isolation Capacitance	Input-output capacitance at 100kHz/0.1V	--	500	--	pF
Operating Temperature	See Fig. 1	-40	--	+85	°C
Storage Temperature		-55	--	+125	
Storage Humidity	Non-condensing	5	--	95	%RH
Pin Soldering Resistance Temperature	Soldering spot is 1.5mm away from case for 10 seconds	--	--	+300	°C
Vibration	10-55Hz, 2G, 30 Min. along X, Y and Z				
Switching Frequency *	PWM mode	--	270	--	kHz
MTBF	MIL-HDBK-217F@25°C	1000	--	--	k hours

Note:\*Switching frequency is measured at full load. The module reduces the switching frequency for light load (below 50%) efficiency improvement.

**Mechanical Specifications**

Case Material	Black plastic; flame-retardant and heat-resistant (UL94 V-0)	
Dimensions	Horizontal package	51.50 x 26.50 x 12.00 mm
	A2S chassis package	76.00 x 31.50 x 21.20 mm
	A4S Din-rail package	76.00 x 31.50 x 25.80 mm
Weight	Horizontal package/A2S chassis package/A4S Din-rail package	23.7g/46.0g/66.0g (Typ.)
Cooling Method	Free air convection	

**Electromagnetic Compatibility (EMC)**

Emissions	CE	CISPR32/EN55032	CLASS A (without extra components)/CLASS B (see Fig.3-② for recommended circuit)
	RE	CISPR32/EN55032	CLASS A (without extra components)/CLASS B (see Fig.3-② for recommended circuit)
Immunity	ESD	IEC/EN61000-4-2	Contact ±4kV perf. Criteria B
	RS	IEC/EN61000-4-3	10V/m perf. Criteria A
	EFT	IEC/EN61000-4-4	±2kV (see Fig.3-① for recommended circuit) perf. Criteria B
	Surge	IEC/EN61000-4-5	line to line ±2kV (see Fig.3-① for recommended circuit) perf. Criteria B
	CS	IEC/EN61000-4-6	3 Vr.m.s perf. Criteria A
	Voltage dips, short interruptions and voltage variations immunity	IEC/EN61000-4-29	0%, 70% perf. Criteria B

**Typical Characteristic Curves**

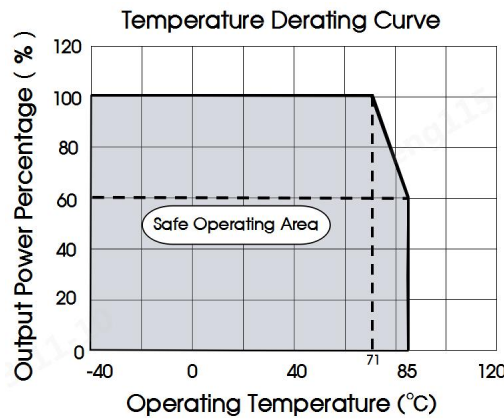
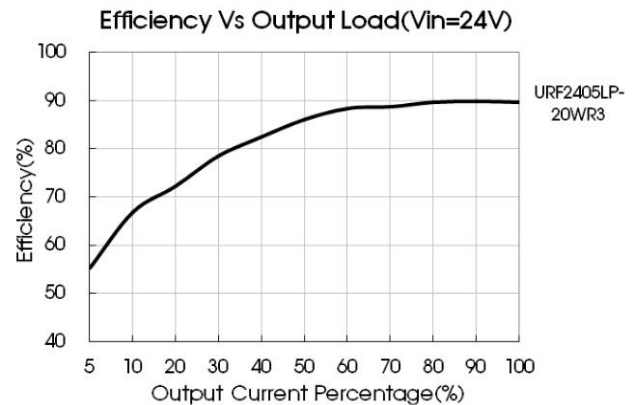
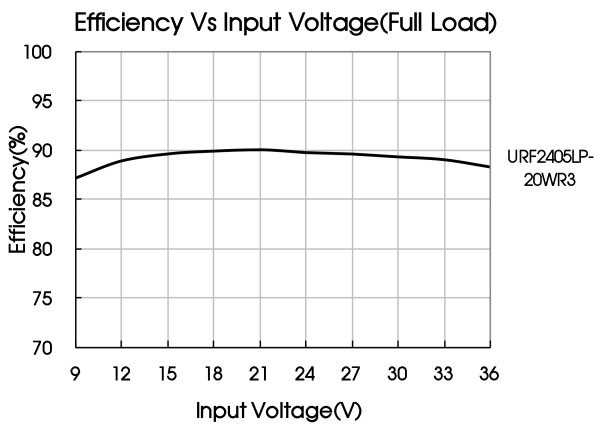
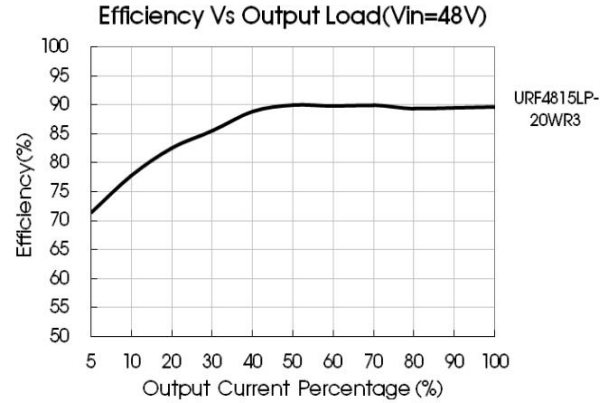
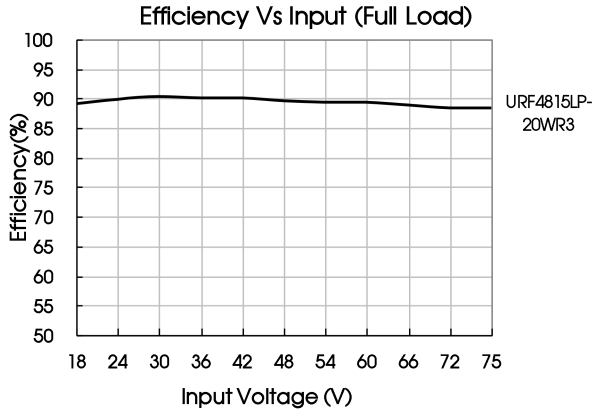

Fig. 1





Design Reference

1. Typical application

All the DC/DC converters of this series are tested before delivery using the recommended circuit shown in Fig. 2. Input and/or output ripple can be further reduced by appropriately increasing the input & output capacitor values  $C_{in}$  and  $C_{out}$  and/or by selecting capacitors with a low ESR (equivalent series resistance). Also make sure that the capacitance is not exceeding the specified max. capacitive load value of the product.

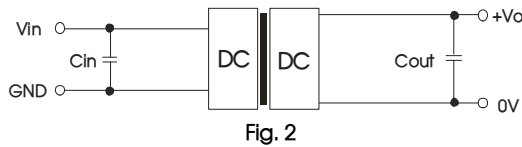

Vout(VDC)	Cin	Cout
3.3/5	100µF/100V	470µF/15V
9/12/15		220µF/25V
18/24		100µF/50V

2. EMC compliance circuit

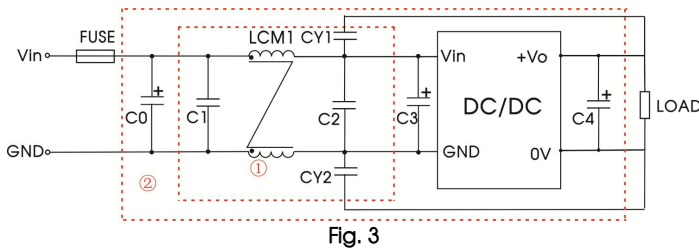

Notes: For EMC tests we use Part ② in Fig. 3 for immunity and part ① for emissions test. Selecting based on needs.

Model	Parameter description	
	Vin: 24VDC	Vin: 48VDC
FUSE	Choose according to actual input current	
C0	1000µF/50V	680µF/100V
C1/C2	1µF/50V	1µF/100V
C3	330µF/50V	330µF/100V
C4	Refer to the Cout in Fig.2	
LCM1	6.8mH	
CY1, CY2	1nF/3kV	

3. Trim Function for Output Voltage Adjustment (open if unused)

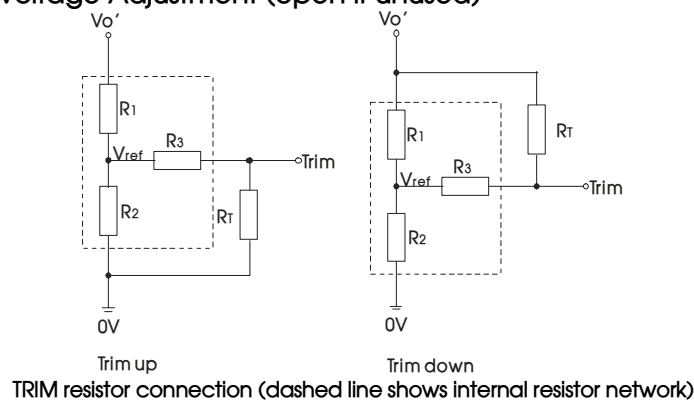

Trim resistor calculation

up:  $R_T = \frac{\alpha R_2}{R_2 - \alpha} \cdot R_3$

$\alpha = \frac{V_{ref}}{V_o' - V_{ref}} \cdot R_1$

down:  $R_T = \frac{\alpha R_1}{R_1 - \alpha} \cdot R_3$

$\alpha = \frac{V_o' - V_{ref}}{V_{ref}} \cdot R_2$

$R_T$  = Trim Resistor value;  
 $\alpha$  = self-defined parameter;  
 $V_o'$  = desired output voltage.

Vout(V)	R1(kΩ)	R2(kΩ)	R3(kΩ)	Vref(V)
3.3	4.775	2.87	12.4	1.25
5	2.883	2.87	10	2.5
9	7.500	2.87	15	2.5
12	11.000	2.87	15	2.5
15	14.494	2.87	15	2.5
18	17.953	2.87	17.4	2.5
24	24.872	2.87	17.8	2.5

4. The products do not support parallel connection of their output

5. For additional information please refer to DC-DC converter application notes on [www.mornsun-power.com](http://www.mornsun-power.com)

URF\_LP-20WR3 Dimensions and Recommended Layout

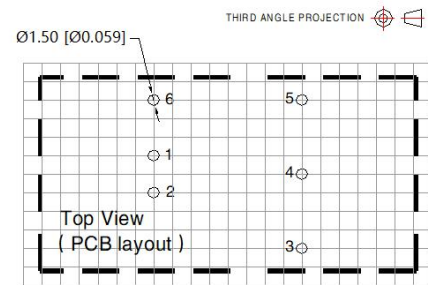
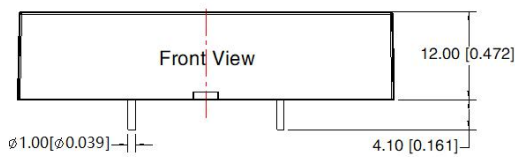

Note: Grid 2.54\*2.54mm

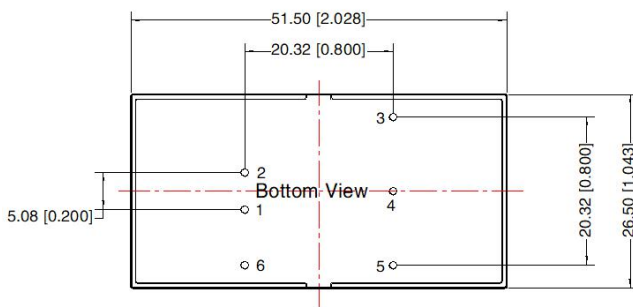

Note:  
Unit: mm[inch]  
Pin diameter tolerances:  $\pm 0.10 [\pm 0.004]$   
General tolerances:  $\pm 0.50 [\pm 0.020]$

Pin-Out	
Pin	Mark
1	GND
2	Vin
3	+Vo
4	Trim
5	0V
6	Ctrl

URF\_LP-20WR3A2S Dimensions and Recommended Layout

THIRD ANGLE PROJECTION 

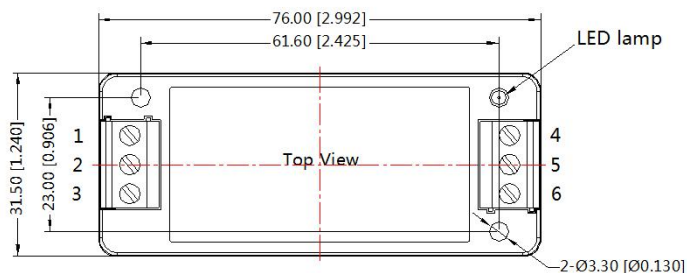

Pin-Out						
Pin	1	2	3	4	5	6
Function	Ctrl	GND	Vin	0V	Trim	+Vo

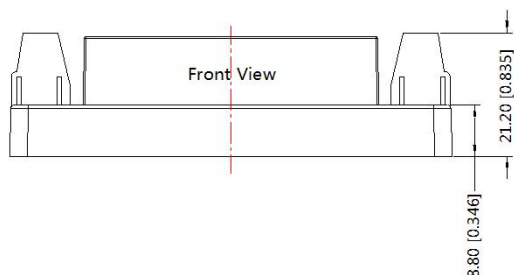

Note:  
Unit: mm[inch]  
Wire range: 24-12 AWG  
Tightening torque: Max 0.4 N·m  
General tolerances: ±1.00[±0.039]

URF\_LP-20WR3A4S Dimensions and Recommended Layout

THIRD ANGLE PROJECTION 

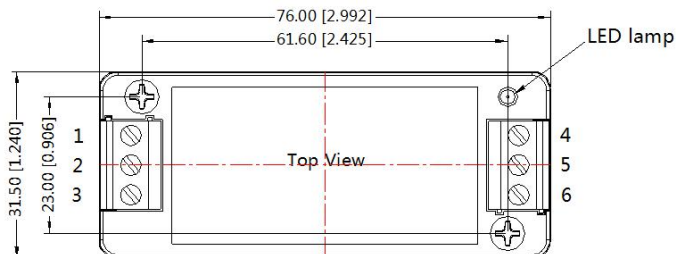

Pin-Out						
Pin	1	2	3	4	5	6
Function	Ctrl	GND	Vin	0V	Trim	+Vo

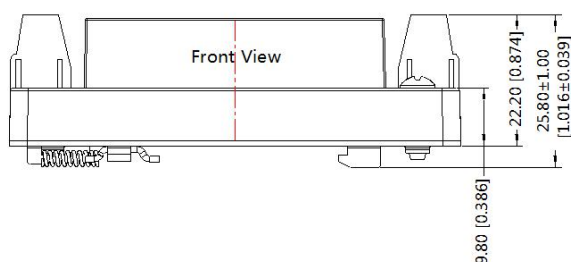

Note:  
Unit: mm[inch]  
Mounting rail: TS35  
Wire range: 24-12 AWG  
Tightening torque: Max 0.4 N·m  
General tolerances: ±1.00[±0.039]

Notes:

1. For additional information on Product Packaging please refer to [www.mornsun-power.com](http://www.mornsun-power.com). The Packaging bag number of Horizontal packaging: 58210039, A2S/A4S packaging number: 58220022;
2. The maximum capacitive load offered were tested at input voltage range and full load;
3. Unless otherwise specified, data in this datasheet should be tested under the conditions of  $T_a=25^{\circ}\text{C}$ , humidity<75%RH with nominal input voltage and rated load;
4. All index testing methods in this datasheet are based on company corporate standards;
5. We can provide product customization service, please contact our technicians directly for specific information;
6. Products are related to laws and regulations: see "Features" and "EMC";
7. Our products shall be classified according to ISO14001 and related environmental laws and regulations, and shall be handled by qualified units.

## Mornsun Guangzhou Science & Technology Co., Ltd.

Address: No. 5, Kehui St. 1, Kehui Development Center, Science Ave., Guangzhou Science City, Huangpu District, Guangzhou, P. R. China  
Tel: 86-20-38601850 Fax: 86-20-38601272 E-mail: [info@mornsun.cn](mailto:info@mornsun.cn) [www.mornsun-power.com](http://www.mornsun-power.com)